

CANopen Interface

Absolute Bus Encoders

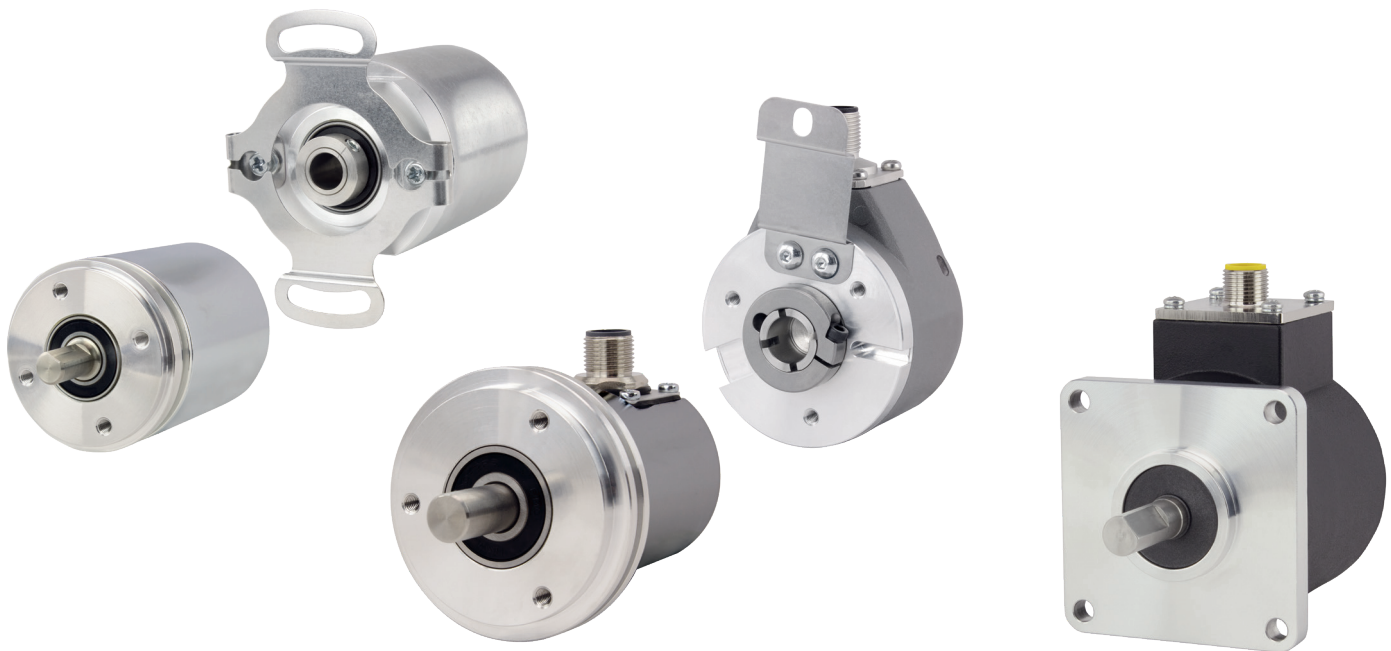

CANopen®

Contents

1. Overview	6	6.8.3 CAM-Polarity-Register	43
1.1 Encoder Types	6	6.8.4 CAM-Low-Limit	43
1.2 About This Manual	6	6.8.5 CAM-High-Limit	43
1.3 Technical Specifications	7	6.8.6 CAM-Hysteresis	43
2. Safety	7	6.9 Device Profile	44
2.1 Work Safely	7	6.10 SYNC	44
2.2 Explanation of Symbols	8	6.11 Encoder Designation	44
3. Parts of the Encoder	8	6.12 Error Behavior	44
3.1 Basic Encoder Design	8	6.13 NMT Startup Behavior	45
3.2 Predefined Connection Settings	9	6.14 Bus-Off Auto-Reset	45
4. Integration	11	6.15 Customer Data	45
4.1 CAN Network Integration	12	6.16 Temperature	45
4.2 SDO Command to Set the Node ID	12	6.17 Verify Configuration	46
4.3 Setting Up the Encoder	13	7. Connection	46
5. CANopen Operation	13	7.1 Mechanical and Electrical Connection	46
5.1 CAN Physical and Transport Layer	13	7.2 Configuration via LSS	47
5.2 CANopen	15	7.2.1 General Settings	47
5.3 Specifications and Profiles	16	7.2.2 Baudrate Setting	50
5.3.1 Overview	16	7.2.3 Node ID Setting	51
5.3.2 Mechanisms of Communication	17	7.3 Configuration via SDO	52
5.3.3 Object Dictionary	17	7.3.1 Reading and Writing on Objects	52
5.4 Network Management (NMT)	18	7.3.2 Baudrate Selection	54
5.5 Heartbeat and Node-Guarding	20	7.3.3 Node-ID Election	55
5.6 Emergency Messages	20	7.3.4 Basic NMT Commands	55
6. Setup	21	7.4 Heartbeat Settings	56
6.1 Communication Objects	21	7.5 PDO Configuration	57
6.2 Device-Specific Objects	26	7.5.1 PDO Parameters	57
6.3 Manufacturer-Specific Objects	34	7.5.2 Synchronous PDO	59
6.4 Network Management (NMT) commands	36	7.5.3 Asynchronous PDO	59
6.5 Heartbeat Protocol	37	7.5.4 Variable PDO-Mapping	60
6.6 Emergency Messages (EMCY)	38	7.6 Changing Resolution and Direction	62
6.7 Error Objects	40	7.7 Position Preset	64
6.7.1 Manufacturer Status Register	40	7.8 Change Speed-Integration and Speed Scaling	65
6.7.2 Alarms	41	7.9 Frequency Limit	65
6.7.3 Warnings	41	7.10 CAM-Configuration	65
6.8 Electronic Cam Switch (CAM)	42	7.11 Saving Into EEPROM	68
6.8.1 CAM-State-Register	42	8. Troubleshooting	69
6.8.2 CAM-Enable-Register	42		

List of Tables

Table 3.2: CAN-Identifier	9
Table 5.3.1: Draft Standards	17
Table 5.3.3 shows the structure of the object dictionary ..	18
Table 6.1: The Object Dictionary	26
Table 6.2: Device-Specific Objects	34
Table 6.3: Manufacturer-Specific Objects	36
Table 6.6: Emergency Error Code List	39
Table 7.1: Pin and Cable Assignment (according to CiA 303)	47
Table 7.2.1: LSS-Selective-Identification-Commands	48
Table 7.2.2: Baudrate-Coding	50
Table 7.3.1: Command Definitions	53
Table 7.3.2: Baudrate Codes	54
Table 7.4: Heartbeat NMT-State-Coding	57
Table 7.5.1A: Default PDO Configuration	57
Table 7.5.1B: Possible PDO Transmission Types	58
Table 7.5.1C: PDO Deactivation	58
Table 7.6: Counting Direction and Scaling Parameters	62

List of Figures

Figure 1.1	6
Figure 3.1: Examples of EPC absolute encoders	9
Figure 3.3: LED Indications	11
Figure 5.11: Example of an Arbitration	14
Figure 5.12: Bitstuffing	15
Figure 5.2: ISO-OSI-Model	16

List of Abbreviations

autom.	automatic
approx.	approximately
CAN	Controller Area Network
CAN-ID	Main part of the arbitration of a CAN-frame
co	constant: parameter is read-only, doesn't change
COB-ID	Communication Object identifier, specifying the CAN-ID and additional parameters for the related communication object
DLC	Data Length Code
DS	Draft Standard
DSP	Draft Standard Proposal
dyn	dynamic; Information changes depending on encoder features
EC	European community
EDS file	Electronic data sheet, standardized file describing a CANopen device
EMC	Electromagnetic compatibility
GND	Ground
i*	Wildcard character for encoder specific information
LED	Light Emitting Diode
LSB	Least Significant Bit/Byte
LSS	Layer Setting Services
MSB	Most Significant Bit/Byte
n.n.	not necessary
NMT	Network Management
Node-ID	Part of CAN-ID; number of the encoder in the CAN network
OSI	Open Systems Interconnection Reference Model
PDO	Process Data Object. Communication object for transmission of process data
res.	reserved
ro	Read Only, but not constant
RTR	Remote Transmission Request
rw	Read/Write: parameter can be read and written
SDO	Service Data Object; communication object providing access to all entries of the object dictionary
SYNC	Synchronizations telegram
comp.	compare

wo	write only
xxb	Mark that (xx) is a binary representation
xxd	Mark that (xx) is a decimal representation
xxh	Mark that (xx) is a hexadecimal representation

1. Overview

1.1 Encoder Types

This manual applies to the following Encoder Products Company encoders:

Encoder type	Product code
Ø36 mm Hollow Bore Encoder	A36HB
Ø36 mm Shaft Encoder	A36SB
Ø2.5" Shaft Encoder	A25SB
Ø58 mm Shaft Bore Encoder	A58HB
Ø58 mm Blind Hollow Bore Encoder	A58HB

The revision number and the serial number vary for each individual encoder and is found on the encoder's label. In Figure 1.1, below, the text circled in red is the revision number of the encoder software, and the text circled in green is the serial number.

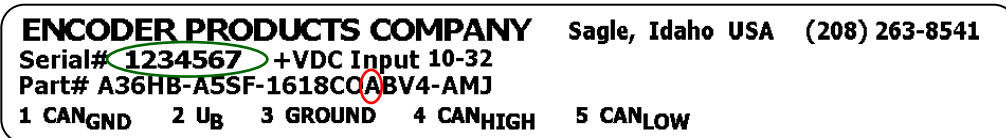

Figure 1.1

1.2 About This Manual

This technical manual describes the different possibilities of mounting and configuring Encoder Products Company encoders with CANopen interface. Use it in addition to other documents published by EPC, such as data sheets, mounting instructions, catalogs, and fliers.

This manual is intended for individuals with technical knowledge in the use of sensors, automation equipment, and CANopen interfaces. If you are inexperienced in this subject, EPC recommends you seek help from experienced per-

sonnel. EPC recommends you carefully review this manual before using the encoder, with special attention paid to the safety advice found throughout this manual.

For optimal use of the device, all information contained in this manual is needed and should be read.

Please retain all included documents for future reference.

1.3 Technical Specifications

An encoder is an industrial sensor for measuring angular positions and derived measurements. This data is processed within the encoder and provided as electronic signals for the connected devices.

The interface and protocol for the communication between the encoder and attached equipment meets the CAN and CANopen specifications. The encoder is capable of CAN 2.0A and CAN 2.0B. The implemented CANopen protocol meets the CiA 406 encoder profile.

To aid in configuring the encoder, electronic data sheets are available for download at www.encoder.com.

MA series encoders are components designed for integration into larger assemblies. It is important to ensure the entire assembly complies with all applicable regulations prior to applying the encoder.

2.Safety

2.1 Work Safely

An EPC absolute encoder with CANopen interface is a sensor for angular measurement and is to be used for this purpose only! The manufacturer denies any liability for damages caused by ignoring this manual. EPC absolute encoders are designed, produced, and distributed for non-safety relevant applications in industrial and commercial environments.

2.2 Explanation of Symbols

Definition:



The “INFO symbol” marks a section or information of particular importance for the further use of the device.



The “IMPORTANT symbol” marks a section or information describing a solution to a certain problem.



The “WARNING symbol” marks a section or information of particular importance to ensure the proper use and protect from risks and dangers.

3. Parts of the Encoder

3.1 Basic Encoder Design

EPC absolute encoders are available in different mechanical versions. The different versions provide key mechanical features to facilitate use in various mountings and environments. Two different versions are shown in Figure 3.1.

The shaft or the hollow bore connects to the rotating part whose angular position or rotation you want to measure. The encoder itself is mounted by tapped bores or flex mounts, depending on the specific configuration.

A cable or M12 sized connector provides the electrical connection to the CAN-network. A bi-color status LED at the top of the encoder indicates the different states of the encoder during use, an especially helpful feature during configuration and troubleshooting.

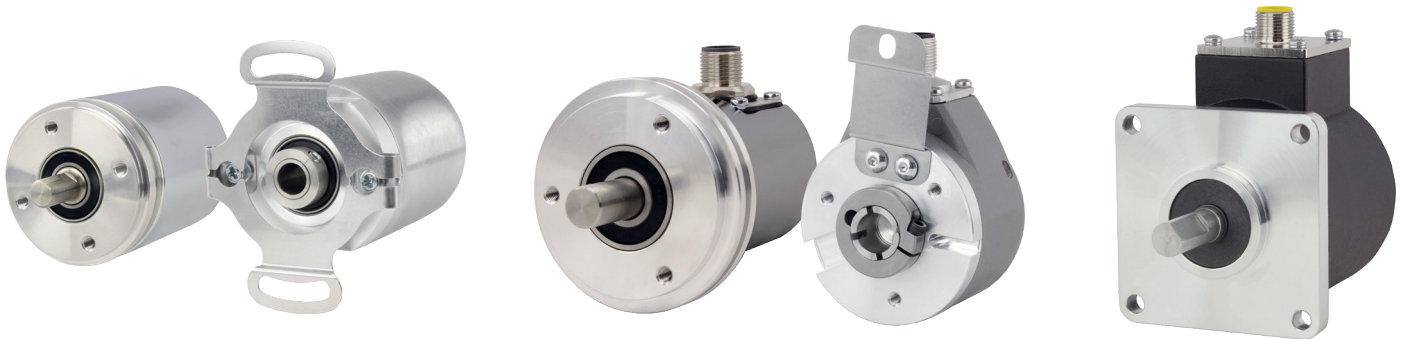

Figure 3.1: Examples of EPC absolute encoders

3.2 Predefined Connection Settings

Services	COB-ID
NMT	000h
SYNC	080h
EMCY	080h + Node-ID
PDO1(tx)	180h + Node-ID
PDO2(tx)	280h + Node-ID
PDO3(tx)	380h + Node-ID
SDO(rx)	600h + Node-ID
SDO(tx)	580h + Node-ID

Table 3.2: CAN-Identifier

By default all EPC CANopen absolute encoders are set on Node-ID=127h and Baudrate=Auto-Detection.

LED Status Indicator and Signal Codes

Definition of LED indication types:

 = red LED indications = "Physical Layer" information

 = green LED indications = "NMT-Status" information

 = LED off

Green ON: Encoder is in OPERATIONAL state

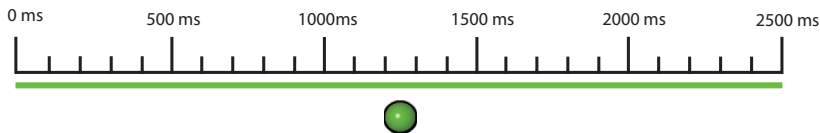

Green blinking: Encoder is in PRE-OPERATIONAL state

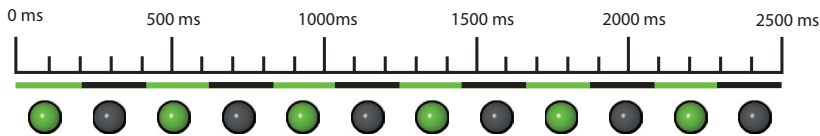

Green single flash: Encoder is in STOPPED state

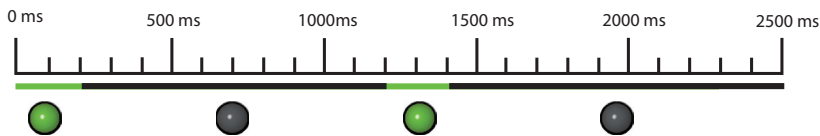

Red ON: NOT ready / BUS-OFF

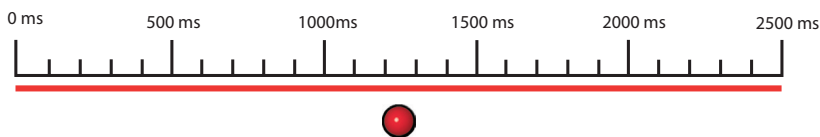

Red single flash: Warning, error frames occurring

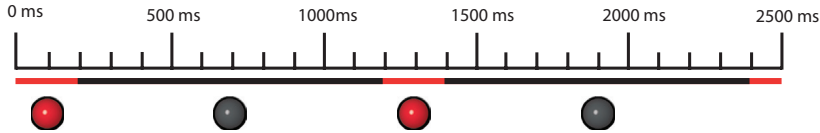

Red double flash: Error, a guard event or a heartbeat event (heartbeat consumer) has occurred

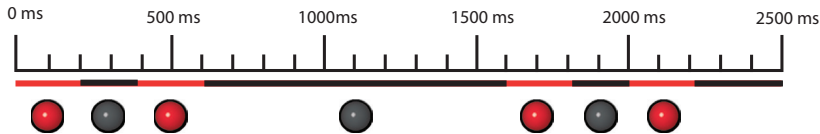

Red triple flash: Encoder is bus-passive

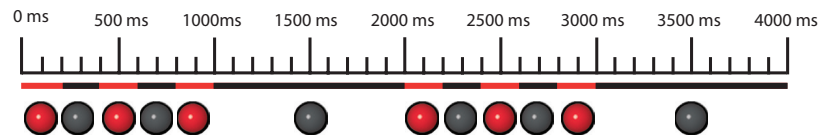

Red-green flickering: Baudrate-Auto-Detection in progress or LSS config modus started

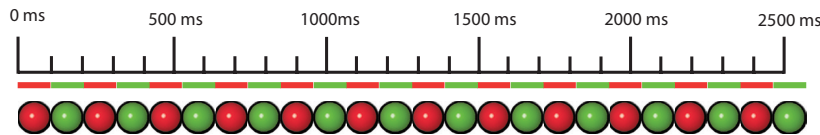

Figure 3.3: LED Indications

4. Integration



The encoder indicates state changes with its Status-LED. See Section 3.3.

4.1 CAN Network Integration

The default node ID of the EPC absolute encoders with CANopen interface (Object 2101h sub-Index: 00h) is 7Fh=127d.

The encoder's baudrate must be set to operate in a CAN-Network. Common ways to set the baudrate are via LSS (CiA DSP-305) or SDO commands. EPC absolute encoders are preset at the factory to automatically detect the baudrate of the network (object 2100h sub-Index: 00h value: 09h Baudrate-auto-detection). Baudrate setup is usually not necessary. To detect the valid baudrate the encoder stays passive and scans the communication on the bus. Once the baudrate is detected, the encoder is set to this rate and switches into pre-operational mode.

To prevent possible collisions resulting from a duplicate assigned node ID it is recommended to use a 1:1 connection with a bus master for configuration (e.g. a laptop computer with suitable hardware and software). Set the master on the intended baudrate and use SDO or LSS services to configure the encoder.

4.2 SDO Command to Set the Node ID

After connecting the encoder to the CAN bus master (e.g., laptop, etc.) the LED starts flickering red and green (see Figure 3.3 LED indications). First, send one or more SYNC messages so the encoder can detect the baudrate:

CAN-ID	DLC	Command	Byte 0	Byte 1	Byte 2	Byte 3	Byte 4	Byte 5	Byte 6
080h	8	00h	00h	00h	00h	00h	00h	00h	00h

To set the encoders node ID the object **2101h**, access Sub-Index 00h. (This is only possible in PRE-OPERATIONAL state.) Send a write-SDO command with the intended node ID (in hex):

CAN-ID	DLC	Command	Object L	Object H	Sub-Index	Byte 0	Byte 1	Byte 2	Byte 3
600h+ID	8	2Fh	01h	21h	00h	Node-ID	00h	00h	00h

An example for a node ID might be:

Node-ID (d)	Node-ID (h)
1	01h

2	02h
127	7Fh

The change of the node ID via SDO takes effect after a reset of the encoder (hard reset or NMT reset). The new node ID is stored into the EEPROM immediately and without any further command. To set the node ID via LSS, refer to **Section 7.2**.

4.3 Setting Up the Encoder

After setting the node ID, mount the encoder and connect it to the application's bus, taking care to follow all proper mounting and safety procedures. Once the encoder is completely integrated into the application you can switch it into OPERATIONAL mode by issuing the "Start-All-Nodes-Command" (see **Section 6.13**)

The encoder is now operational (LED shows green ON) and starts sending data via process data objects (PDO). The encoder's default configuration triggers PDO1 with a change in the position value. The position value is the object 6004h and is transmitted as an Unsigned32. By default PDO2 transmits the same value but synchronously on the reception of a SYNC message. Heartbeat is switched off and will not be transmitted by default. The encoder is now configured and ready for basic applications.

5. CANopen Operation

5.1 CAN Physical and Transport Layer

A Controller Area Network, or CAN, is a multi-master serial bus system designed to allow microcontrollers and devices (nodes) to communicate with each other without a host computer. Each node is able to send and receive messages, but not simultaneously. It uses cyclic redundancy check (CRC) and other safety mechanisms to ensure the integrity of the data transmission and a mechanism commonly referred to as bit stuffing, the process of inserting non-information bits into the data stream, to provide synchronization. CAN operates with the CSMA/CA (Carrier Sense Multiple Access / Collision Avoidance) method. This means that collisions during bus access are avoided by a process known as bitwise arbitration. Bitwise arbitration uses the binary representation of the node or message ID to determine the transmission priority. The signal pattern is encoded with NRZ-L (Non Return To Zero -Low) and is sensed by all nodes.

The common CAN implementation with copper wire operates with differential signals transmitted via two wires: CAN_{HIGH} and CAN_{LOW}. These differential signals provide a good common mode rejection ratio (CMRR).

The topology of a CAN network is a line, which can be extended by stubs. The maximum length of a stub is limited to 0.5m. The network must always be terminated on each end with 120 Ohms resistance between CAN_{HIGH} und CAN_{LOW}. Other locations or values are not allowed.

The arbitration mentioned before is used to control the bus access from the nodes by prioritizing the CAN-Identifier of the different messages. Every node monitors the bus. If more than one node wants access to the bus, the node with the highest message ID succeeds and the other nodes retreat until there is silence on the bus (see Figure 5.11, below). The first dominant bit of the ID sent overwrites the corresponding recessive bit of the other IDs. In the event more than one node uses the same CAN-ID an error occurs only at a collision within the rest of the frame. On principle a CAN-ID should only be used by a single node.

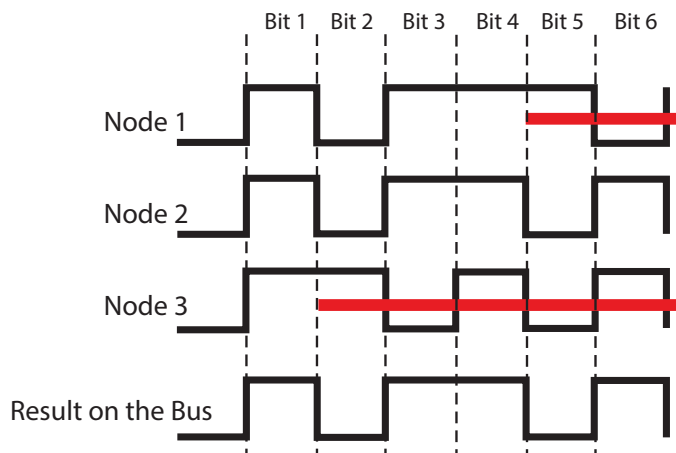

Figure 5.11: Example of an Arbitration

Messages are ranked for arbitration. The message with the lowest ID has the highest priority and has almost instant access to the bus, except that an ongoing transmission will not be interrupted. Time critical messages should be assigned to the higher priority CAN-IDs, but even then there is no determination in the time of transmission (non-deterministic transmission).

All nodes must be synchronized for arbitration. Due to the lack of a separate clock signal, the transmission of many identical bits in line would lead to the loss of synchronization. Bit stuffing is used to prevent loss of synchronization. After five equal bits, a complementary bit is inserted into the transmission (the application will not notice), and the nodes can then keep resynchronizing on the bit flanks. (See Figure 5.12).

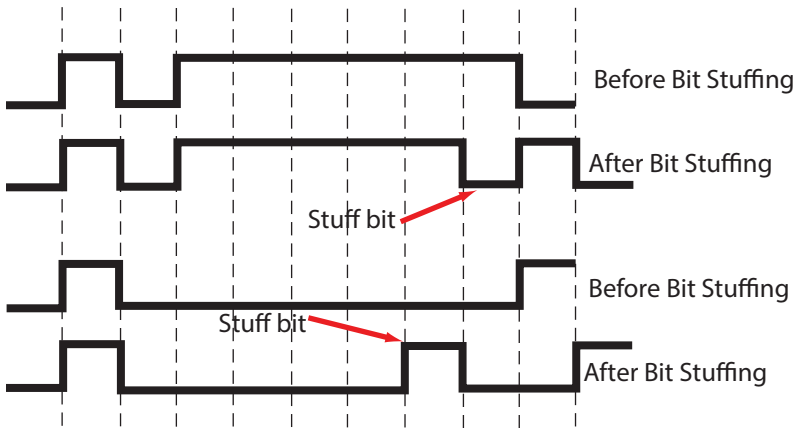
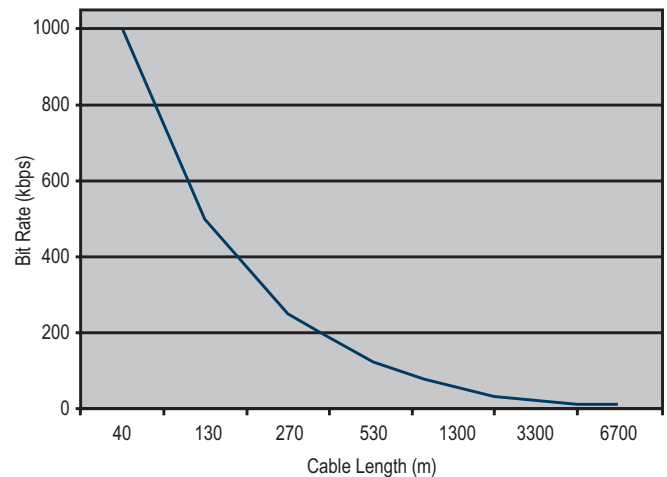

Figure 5.12: Bitstuffing

A CAN network is capable of baudrates up to 1 Mbit/s. Due to the required synchronization of the nodes, the maximum delay caused by the length of the cable must be limited. The limitation corresponds with the baudrate. Below is a common recommendation of the maximum cable length at several baudrates:

Baudrates	Max. cable length
10 kBit/s	6.7 km
20 kBit/s	3.3 km
50 kBit/s	1.3 km
125 kBit/s	530 m
250 kBit/s	270 m
500 kBit/s	130 m
1 MBit/s	<40 m



5.2 CANopen

CANopen is a specified higher protocol (layer 7 protocol) See Figure 5.2, below.

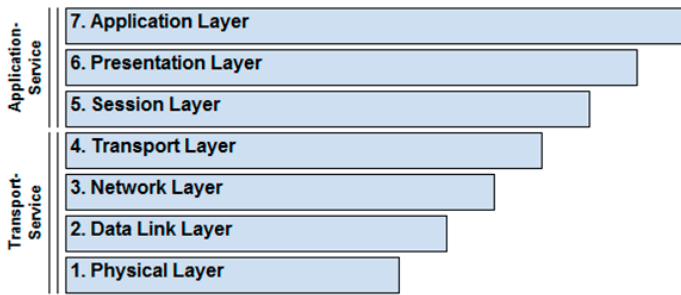

Figure 5.2: ISO-OSI-Model

With CANopen it is possible to transfer larger amounts of data, emergency telegrams, and process data. CANopen describes how the communication is performed. This means that parameters to configure a device are transmitted in a defined form (profile).

A CANopen profile defines objects representing the different functions of a device. These objects form a table called an object dictionary. The communication profile defines the basic services and parameters of a CANopen device (e.g. service data objects or SDOs, process data objects or PDOs, used CAN-IDs, and so on). The device profile defines the specific functions of a device family (e.g., encoders, i/o devices, etc.). For encoders the device profile is the encoder profile CiA 406.

5.3 Specifications and Profiles

5.3.1 Overview

The CANopen specifications are defined by the CiA in Draft Standards. The following specifications in particular apply to EPC absolute encoders:

Specification	Description
CiA 301	Application Layer and Communication Profile
CiA 303	Cabling/pin assignment, Representation of units, Indicator specification
CiA 305	Configuration of baudrate und node ID via LSS
CiA 306	Electronic Data Sheet
CiA 406	Encoder profile

Table 5.3.1: Draft Standards

5.3.2 Mechanisms of Communication

There are several different CANopen communication services:

<p>SDO Service Data Object</p>	<p>Use: for access to the object dictionary. There is one single SDO-channel.</p> <p>Two identifiers are assigned to the SDO channel, one for each direction of transmission.</p> <p>A SDO transmission will always be acknowledged by the receiver. In the event of a failure an “abort message” is sent. The internal delay time of EPC absolute encoders with CANopen interface is 1 millisecond maximum.</p>
<p>PDO Process Data Object</p>	<p>Use: for transmission of process data. EPC absolute encoders with CANopen interface provide up to four PDOs. A PDO uses the full length of the data area of a CAN frame (8 bytes) for the process data without additional overhead. PDOs will not be acknowledged and are suitable for time critical applications.</p> <p>By using the full 8 bytes for data, there is no additional information on what objects are transmitted. Therefore the PDO producer and the PDO consumer have to define the PDO-mapping.</p> <p>PDOs can be sent in different ways:</p> <p>On request: A node sends a RTR frame to ID of the designated PDO and the encoder returns the PDO. (The CiA strongly recommends not to use RTR frames. Therefore RTR is not supported by Encoder Products Company encoders.)</p> <p>Synchronously: On the reception of a SYNC message the node send its PDOs.</p> <p>Asynchronously: The sending of the PDOs is triggered by an internal event (e.g. the internal event timer).</p>

5.3.3 Object Dictionary

The object dictionary lists all data types, objects and functions of the communication and the device profile. There are also manufacturer specific objects listed.

The objects are addressed by 16-bit indices (lines) and 8-bit sub-indices (columns).

Index (hex)	Object description
0000	reserved
0001 001F	static data types
0020 003F	complex data types
0040 005F	manufacturer specific data types
0060 007F	profile specific static data types
0080 009F	profile specific complex data types
00A0 0FFF	reserved
1000 1FFF	communication profile objects
2000 5FFF	manufacturer specific objects
6000 9FFF	objects from the "Standard device profiles"
A000 AFFF	network variables
B000 FFFF	reserved / system variables

Table 5.3.3 shows the structure of the object dictionary

5.4 Network Management (NMT)

A CANopen network always needs a network management master. The NMT-master controls the NMT states of all connected nodes.

A node can be switched into three different states:

- Pre-Operational
- Operational
- Stopped



After a CANopen node is switched on, and the communication and the internal application is initialized, the node switches into pre-operational state. From this state, the NMT-Master can switch the node into the other states. To show that a node is ready after boot-up, it sends a "boot-up message".

These messages use the CAN-ID of the Emergency service (EMCY). The message is permanently associated with the node ID.

Description of the NMT-states:

SDO communication is enabled.

PDO communication is disabled.

Pre-Operational

Object	Communication enabled
SDO	yes
PDO	no
NMT	yes
SYNC	no
EMCY	yes
Heartbeat	yes

Device fully operational and can send and receive PDOs.

Operational

Object	Communication enabled
SDO	yes
PDO	yes
NMT	yes
SYNC	yes
EMCY	yes
Heartbeat	yes

The communication is almost completely disabled. The device only reacts on NMT commands (e.g. start node).

Stopped

Object	Communication enabled
SDO	no

PDO	no
NMT	yes
SYNC	no
EMCY	no
Heartbeat	yes

5.5 Heartbeat and Node-Guarding

There are two possible ways to supervise the operational availability of a CAN node during operation:

- Heartbeat
- Node-Guarding

The heartbeat protocol is independent from the master. It is the recommended mechanism. The device automatically sends a cyclic “life” message. Encoder Products Company recommends the use of the heartbeat protocol.

When using the node guarding protocol, the NMT master sends RTR frames to the slaves, which have to answer within a defined time. If the answer is missing, this is detected by the master. This protocol leads to a high dependence on the master.

5.6 Emergency Messages

Failures of a CAN node are announced by emergency messages (EMCY message). The EMCY message contains a error code identifying the problem. A node also can be configured to send no EMCYs.

6.Setup

6.1 Communication Objects

The communication objects comply with the CiA specification 301 v4.02 and have the object addresses 1000h to 1FFFh.

Object No.	Name	Sub-Index	Function	Data Type	ro wr co	Mapping	Default Value
1000h	Device type	0h	(MSB) Encoder type (LSB) device profile no	Unsigned32	co	no	Multiturn: 0002 0196h Single- turn: 0001 0196h
1001h	Error register	0h	Indication of internal failures and part of an emergency objects	Unsigned8	ro	yes	00h
1002h	Manufacturer status register	0h	General status register for manufacturer specific purpose	Unsigned32	ro	yes	0000 0000h
1003h	PreDefined Error Field	00h	stores occurring errors indicated by EMCY (volatile)	Unsigned8	rw	no	dyn.
		01h	Standard error field 1	Unsigned32	ro		
		02h	Standard error field 2	Unsigned32	ro		
		03h	Standard error field 3	Unsigned32	ro		
		04h	Standard error field 4	Unsigned32	ro		
		05h	Standard error field 5	Unsigned32	ro		

Object No.	Name	Sub-Index	Function	Data Type	ro wr co	Mapping	Default Value
1005h	COB-ID SYNC Message	00h	COB-ID of the SYNC message	Unsigned32	rw	no	0000 0080h
1009h	Manufacturer hardware version	00h	Contains the number of the hardware revision assigned by the manufacturer.	string16	co	no	i*
100Ah	Manufacturer software version	00h	Contains the number of the software revision assigned by the manufacturer.	string72	co	no	i*
100Ch	Guard time	00h	Defines the guard time in milliseconds; 0h= node guard protocol disabled.	Unsigned16	rw	no	0000h
100Dh	Life time factor	00h	Contains the life time factor for the node guard protocol.	Unsigned8	rw	no	00h
1010h	Store Parameters	00h		Unsigned8	co	no	04h
		01h	Save all parameters	Unsigned32	rw		
		02h	Save communication	Unsigned32	rw		
		03h	Save application	Unsigned32	rw		
		04h	Save manufacturer	Unsigned32	rw		
1011h	Restores default Parameters	00h	Restores factory settings	Unsigned8	co		04h
		01h	Restores all parameters	Unsigned32	rw		
		02h	Restores communication	Unsigned32	rw		
		03h	Restore application	Unsigned32	rw		
		04h	Restore manufacturer	Unsigned32	rw		

Object No.	Name	Sub-Index	Function	Data Type	ro wr co	Mapping	Default Value
v	COB-ID Emergency object	00h	Defines the COB-ID of the emergency object (EMCY).	Unsigned32	rw	no	0000 0080h+ node-ID
1015h	Inhibit time EMCY	00h	Defines the minimum pause (in 100 ms steps) between the sending of EMCYs	Unsigned16	rw	no	0000h
1016h	Consumer heartbeat time	00h	Defines the time frame within the heartbeat consumer awaits a incoming heartbeat otherwise triggering an EMCY.	Unsigned8	co		01h
		01h	Heartbeat-Consumer cycletime	Unsigned32	rw		0000 0000h
1017h	Producer heartbeat time	00h	Defines the heartbeat cycle time in steps of 1 ms. 0h = heartbeat disabled.	Unsigned16	rw	no	0000h
1018h	Identity object	00h		Unsigned8	co	no	04h
		01h	Vendor-ID	Unsigned32	co		1F02 0001h
		02h	Product Code (MA SERIES)	Unsigned32	co		5743 4741h
		03h	Revision Number	Unsigned32	co		i*
		04h	Serial Number	Unsigned32	co		i*
1020h	Verify configuration	00h	Here the time of the last configuration can be logged. If the configuration was changed after setting this value, the object is set to zero autonomous.	Unsigned8	co	no	02h

Object No.	Name	Sub-Index	Function	Data Type	ro wr co	Mapping	Default Value
		01h	Configuration date	Unsigned32	rw		0000 0000h
		02h	Configuration time	Unsigned32	rw		0000 0000h
1029h	Error behavior	00h	Changing the encoder's behavior in case of a node-guarding or heart-beat event, etc.	Unsigned8	co	no	02h
		01h	Communication error	Unsigned8	rw		00h
		02h	Encoder Error	Unsigned8	rw		00h
1800h	Transmit PDO1 communication parameters	00h	Defines the communication parameters of the 1st TPDO	Unsigned8	co	no	05h
		01h	COB-ID for PDO	Unsigned32	rw		180h+ Node-ID
		02h	Transmission type	Unsigned8	rw		FEh
		05h	Event-timer	Unsigned16	rw		0000h
1801h	Transmit PDO2 communication parameters	00h	Defines the communication parameters of the 2nd TPDO	Unsigned8	co	no	05h
		01h	COB-ID for PDO	Unsigned32	rw		280h+ Node-ID
		02h	Transmission type	Unsigned8	rw		01h
		05h	Event-timer	Unsigned16	rw		0000h
1802h	Transmit PDO3 communication parameters	00h	Defines the communication parameters of the 3rd TPDO	Unsigned8	co	no	05h
		01h	COB-ID for PDO	Unsigned32	rw		380h+ Node-ID

Object No.	Name	Sub-Index	Function	Data Type	ro wr co	Mapping	Default Value
		02h	Transmission type	Unsigned8	rw		01h
		05h	Event-timer	Unsigned16	rw		0000h
1803h	Transmit PDO4 communication parameters	00h	Defines the communication parameters of the 4th TPDO	Unsigned8	co	no	05h
		01h	COB-ID for PDO	Unsigned32	rw		480h+ Node-ID
		02h	Transmission type	Unsigned8	rw		01h
		05h	Event-timer	Unsigned16	rw		0000h
1A00h	TPDO1 mapping parameter	00h	Defines the PDO-mapping of the 1st TPDO	Unsigned8	rw	no	01h
		01h	Mapped application object 1	Unsigned32	rw		6004 0020h
	Variable, depends on sub-index 00h	02h-08h	Mapped application object 2 -8	Unsigned32	rw		
1A01h	TPDO2 mapping parameter	00h	Defines the PDO-mapping of the 2nd TPDO	Unsigned8	rw	no	01h
		01h	Mapped application object 1	Unsigned32	rw		6004 0020h
	Variable, depends on sub-index 00h	02h-08h	Mapped application object 2 -8	Unsigned32	rw		
1A02h	TPDO3 mapping parameter	00h	Defines the PDO-mapping of the 3rd TPDO	Unsigned8	rw	no	01h
		01h	Mapped application object 1	Unsigned32	rw		6004 0020h
	Variable, depends on sub-index 00h	02h-08h	Mapped application object 2 -8	Unsigned32	rw		

Object No.	Name	Sub-Index	Function	Data Type	ro wr co	Mapping	Default Value
1A03h	TPDO4 mapping parameter	00h	Defines the PDO-mapping of the 4th TPDO	Unsigned8	rw	no	01h
		01h	Mapped application object 1	Unsigned32	rw		6004 0020h
	Variable, depends on sub-index	02h-08h	Mapped application object 2 -8	Unsigned32	rw		
	00h						
1F80h	NMT-Start-up-behavior	00h	Defines the start-up behavior of the encoder	Unsigned32	rw	no	0000 0000h

Table 6.1: The Object Dictionary

6.2 Device-Specific Objects

The device specific objects comply with the CiA encoder profile specification 406 v3.2 and have the object addresses range 6000h to 9FFFh.

Object No.	Name	Sub-Index	Function	Data Type	ro wt co	Mapping	Default Value
6000h	Operating parameters	00h	Changing / Indicating the operating parameters	Unsigned16	rw	no	dyn
6001h	Measuring units per revolution	00h	Changing / Indicating the single turn resolution (STR)	Unsigned32	rw	no	0000 4000h

Object No.	Name	Sub-Index	Function	Data Type	ro wt co	Mapping	Default Value
6002h	Total measuring range	00h	Changing/indicating the total measuring range	Unsigned32	rw	no	FFFF FFFFh
6003h	Preset value	00h	Setting/indicating the preset value to adapt the position value to the application	Unsigned32	rw	no	0000 0000h
6004h	Position value	00h	Current position value	Unsigned32	ro	yes	dyn
6008h	High precision position value	00h	Current position value, when measuring range >32 bit	Unsigned64	ro	yes	dyn
6009h	High precision preset Value	00h	Setting/indicating the High-precision-preset value	Unsigned64	rw	no	0000 0000 0000 0000h
6030h	Speed value	00h	Rotation speed in units (bit) per second	Unsigned8	ro	yes	01h
		01h	Speed value	Signed16	ro		dyn
6040h	v	00h	Accelleration value in units (bit) per second ²	Unsigned8	ro	yes	01h
		01h	Acceleration value	Signed16	ro		dyn
6050h	Jerk Value	00h	Jerk value in units (bit) per second ³	Unsigned8	ro	yes	01h
		01h	Jerk value	Signed16	ro		dyn
6200h	Cyclic-Timer	00h	Changing / Indicating the transmission periode of asynchronous TPDOs;	Unsigned16	rw	no	0001h
6300h	Cam state register	00h	Status bits of the cams of the corresponding cam channel	Unsigned8	ro	yes	01h

Object No.	Name	Sub-Index	Function	Data Type	ro wt co	Mapping	Default Value
		01h	Cam state channel1 0b=inactiv 1h=activ	Unsigned8	ro		00h
6301h	Cam enable register	00h	Changing/indicating the cam enable bits of the corresponding cam channel	Unsigned8	ro	no	01h
		01h	Cam enable channel1 0b=inactiv 1b=activ	Unsigned8	rw		00h
6302h	Cam polarity register	00h	Changing/indicating the inversion of the corresponding cam in (6300h)	Unsigned8	ro	no	01h
		01h	Cam polarity channel1 0b=cam state not inverted 1b=cam state inverted	Unsigned8	rw		00h
6310h	Cam1 low limit	00h	Changing/indicating the lower switching point of the 1st cam	Unsigned8	co	no	01h
		01h	Changing/indicating the lower switching point of the 1st cam of the 1st channel	Signed32	rw		0000 0000h
6311h	Cam2 low limit	00h	Changing/indicating the lower switching point of the 2nd cam	Unsigned8	co	no	01h
		01h	Changing/indicating the lower switching point of the 2nd cam of the 1st channel	Signed32	rw		0000 0000h
6312h	Cam3 low limit	00h	Changing/indicating the lower switching point of the 3rd cam	Unsigned8	co	no	01h

Object No.	Name	Sub-Index	Function	Data Type	ro wt co	Mapping	Default Value
		01h	Changing/indicating the lower switching point of the 3rd cam of the 1st channel	Signed32	rw		0000 0000h
6313h	Cam4 low limit	00h	Changing/indicating the lower switching point of the 4th cam	Unsigned8	co	no	01h
		01h	Changing/indicating the lower switching point of the 4th cam of the 1st channel	Signed32	rw		0000 0000h
6314h	Cam5 low limit	00h	Changing/indicating the lower switching point of the 5th cam	Unsigned8	co	no	01h
		01h	Changing/indicating the lower switching point of the 3rd cam of the 5th channel	Signed32	rw		0000 0000h
6315h	Cam6 low limit	00h	Changing/indicating the lower switching point of the 6th cam	Unsigned8	co	no	01h
		01h	Changing/indicating the lower switching point of the 6th cam of the 1st channel	Signed32	rw		0000 0000h
6316h	Cam7 low limit	00h	Changing/indicating the lower switching point of the 7th cam	Unsigned8	co	no	01h
		01h	Changing/indicating the lower switching point of the 7th cam of the 1st channel	Signed32	rw		0000 0000h

Object No.	Name	Sub-Index	Function	Data Type	ro wt co	Mapping	Default Value
6317h	Cam8 low limit	00h	Changing/indicating the lower switching point of the 8th	Unsigned8	co	no	01h
6320h	Cam1 high limit	00h	Changing/indicating the upper switching point of the 1st cam	Unsigned8	co	no	01h
6321h	Cam2 high limit	00h	Changing/indicating the upper switching point of the 2nd cam	Unsigned8	co	no	01h
6322h	Cam3 high limit	00h	Changing/indicating the upper switching point of the 3rd cam	Unsigned8	co	no	01h
6323h	Cam4 high limit	00h	Changing/indicating the upper switching point of the 4th cam	Unsigned8	co	no	01h
6324h	Changing indicating the upper switching point of the 5th cam	Unsig ned8co		no	01h		
		01h	Changing/indicating the upper switching point of the 5th cam of the 1st channel	Signed32	rw		0000 0000h
6325h	Cam6 high limit	00h	Changing/indicating the upper switching point of the 6th cam	Unsigned8	co	no	01h
		01h	Changing/indicating the upper switching point of the 6th cam of the 1st channel	Signed32	rw		0000 0000h
6326h	Cam7 high limit	00h	Changing/indicating the upper switching point of the 7th cam	Unsigned8	co	no	01h

Object No.	Name	Sub-Index	Function	Data Type	ro wt co	Mapping	Default Value
		01h	Changing/indicating the upper switching point of the 7th cam of the 1st channel	Signed32	rw		0000 0000h
6327h	Cam8 high limit	00h	Changing/indicating the upper switching point of the 8th cam	Unsigned8	co	no	01h
		01h	Changing/indicating the upper switching point of the 8th cam of the 1st channel	Signed32	rw		0000 0000h
6330h	Cam1 hysteresis	00h	Changing/indicating the hysteresis for the 1st cam	Unsigned8	co	no	01h
		01h	Changing/indicating the hysteresis for the 1st cam of the 1st channel	Unsigned32	rw		0000 0000h
6331h	Cam2 hysteresis	00h	Changing/indicating the hysteresis for the 2nd cam	Unsigned8	co	no	01h
		01h	Changing/indicating the hysteresis for the 2nd cam of the 1st channel	Unsigned32	rw		0000 0000h
6332h	Cam3 hysteresis	00h	Changing/indicating the hysteresis for the 3rd cam	Unsigned8	co	no	01h
		01h	Changing/indicating the hysteresis for the 3rd cam of the 3rd channel	Unsigned32	rw		0000 0000h
6333h	Cam4 hysteresis	00h	Changing/indicating the hysteresis for the 4th cam	Unsigned8	co	no	01h
		01h	Changing/indicating the hysteresis for the 4th cam of the 1st channel	Unsigned32	rw		0000 0000h

Object No.	Name	Sub-Index	Function	Data Type	ro wt co	Mapping	Default Value
6334h	Cam5 hysteresis	00h	Changing/indicating the hysteresis for the 5th cam	Unsigned8	co	no	01h
		01h	Changing/indicating the hysteresis for the 5th cam of the 5th channel	Unsigned32	rw		0000 0000h
6335h	Cam6 hysteresis	00h	Changing/indicating the hysteresis for the 6th cam	Unsigned8	co	no	01h
		01h	Changing/indicating the hysteresis for the 6th cam of the 1st channel	Unsigned32	rw		0000 0000h
6336h	Cam7 hysteresis	00h	Changing/indicating the hysteresis for the 7th cam	Unsigned8	co	no	01h
		01h	Changing/indicating the hysteresis for the 7th cam of the 1st channel	Unsigned32	rw		0000 0000h
6337h	Cam8 hysteresis	00h	Changing/indicating the hysteresis for the 8th cam	Unsigned8	co	no	01h
		01h	Changing/indicating the hysteresis for the 8th cam of the 1st channel	Unsigned32	rw		0000 0000h
6400h	Area state register	00h	Indicating if the current position is in or outside the work area	Unsigned8	co	yes	01h
		01h	Status of the area state register: 00h=within area; 03h=outside work area,overflow 05h=outside work area, underflow	Unsigned8	ro		dyn
6401h	Work area low limit	00h	Number of sub-indices	Unsigned8	co	no	01h
		01h	Changing/indicating the work area low limit	Signed32	rw		0000 0000h

Object No.	Name	Sub-Index	Function	Data Type	ro wt co	Mapping	Default Value
6402h	Work area high limit	00h	Number of sub-indices	Unsigned8	co	no	01h
		01h	Changing/indicating the work area high limit	Signed32	rw		0000 0000h
6500h	Operating-status	00h	Indicates the operating state of the device	Unsigned16	ro	no	dyn
6501h	Measuring units per revolution	00h	Indication of the single-turn resolution	Unsigned32	co	no	0000 4000h
6502h	Number of distinguishable revolutions	00h	Indication of the multi-turn resolution	Unsigned16	co	no	Singleturn: 0001h Multi-turn: FFFFh
6503h	Alarms	00h	Alarm set by malfunction.	Unsigned16	ro	yes	dyn
6504h	Supported alarms	00h	Information about supported alarms.	Unsigned16	co	no	F003h
6505h p. 22	Warnings	00h	Warning set on deviation of certain parameters.	Unsigned16	ro	yes	dyn
6506h	Supported warnings	00h	Information about supported warnings.	Unsigned16	co	no	3005h
6507h	Profile and software version	00h	Revision of the implemented encoder profile and software	Unsigned32	co	no	0105 0302h
6508h	Operating time	00h	not supported	Unsigned32	co	no	FFFF FFFFh
6509h	Offset value	00h	Offset value, calculated from the preset value (6003h)	Signed32	ro	no	0000 0000h
650Ah	Module identification	00h	manufacturer specific offset	Unsigned8	ro	no	01h

Object No.	Name	Sub-Index	Function	Data Type	ro wt co	Mapping	Default Value
		01h	Manufacturer offset value	Signed32	ro	no	dyn
650Bh	Serial number	00h	Serial number of the encoders, hard wired with object 1018h-04h	Unsigned8	co	no	01h
		01h	Serial number	Unsigned32	ro		j*
6510h	Number of high-precision-revolutions	00h	Indicates the maximum possible high-precision multiturn resolution	Unsigned40	co	no	0080 0000 0000h

Table 6.2: Device-Specific Objects

6.3 Manufacturer-Specific Objects

The objects 2000h to 5FFFh are manufacturer specific and not defined by the CiA.

Object No.	Name	Sub-Index	Function	Data Type	ro rw co	Mapping	Default Value
2100h	Baudrate	00h	Setting the baudrate	Unsigned8	rw	no	09h
2101h	Node-ID	00h	Setting the node-ID	Unsigned8	rw	no	7Fh
2103h	BUS-Off Auto-Reset	00h	Defines the time in BUS OFF, before automatically resetting. 0h = no automatic reset, 01h-FFh = time in sec.	Unsigned8	rw	no	00h
2105h	Integration value	00h	Number of filter steps for speed, acceleration and jerk	Unsigned8	rw	no	02h

Object No.	Name	Sub-Index	Function	Data Type	ro rw co	Mapping	Default Value
		01h	Integration -Position value filter	Unsigned8	rw		04h
		02h	Integration -Speed value filter	Unsigned16	rw		03E8h
2106h	Speed scaling	00h	Scaling of the speed value	Unsigned8	co	no	02h
		01h	Multiplicator	Unsigned16	rw		0001h
		02h	Divisor	Unsigned16	rw		0001h
2107h	Frequency Limit	00h	Limit for Speed value	Unsigned16	rw	no	00FFh
2120h	Customer EEPROM area	00h	Object to store any customer data.	Unsigned8	co	no	08h
		01h	Customer data 1	Unsigned32	rw		FFFF FFFF
		02h	Customer data 2	Unsigned32	rw		FFFF FFFF
		03h	Customer data 3	Unsigned32	rw		FFFF FFFF
		04h	Customer data 4	Unsigned32	rw		FFFF FFFF
		05h	Customer data 5	Unsigned32	rw		FFFF FFFF
		06h	Customer data 6	Unsigned32	rw		FFFF FFFF
		07h	Customer data 7	Unsigned32	rw		FFFF FFFF
		08h	Customer data 8	Unsigned32	rw		FFFF FFFF
2500h	Temperature Object	00h	Monitoring the internal operating temperature	Unsigned8	co	yes	05h
		01h	Current temperature value	Signed16	ro		dyn
		02h	Upper Limit	Signed16	rw		100°
		03h	Lower Limit	Signed16	rw		-40°
		04h	Maximum value occurred	Signed16	ro		dyn
		05h	Minimum value occurred	Signed16	ro		dyn
2502h	Error History	00h	Non-volatile error history.	Unsigned32	co	no	dyn
		01h	Standard Error field 1	Unsigned32	ro		
		02h	Standard Error field 2	Unsigned32	ro		
		03h	Standard Error field 3	Unsigned32	ro		

Object No.	Name	Sub-Index	Function	Data Type	ro rw co	Mapping	Default Value
		04h	Standard Error field 4	Unsigned32	ro		
		05h	Standard Error field 5	Unsigned32	ro		
2503h	Alarms History	00h	Logging of alarms occurred. Number of alarms.	Unsigned8	co	no	
		01h	Alarm 1	Unsigned16	ro		
		02h	Alarm 2	Unsigned16	ro		
		03h	Alarm 3	Unsigned16	ro		
		04h	Alarm 4	Unsigned16	ro		
		05h	Alarm 5	Unsigned16	ro		
2504h	Warnings History	00h	Logging of warnings occurred. Number of warnings.	Unsigned8	rw	no	
		01h	Warning 1	Unsigned16	ro		
		02h	Warning 2	Unsigned16	ro		
		03h	Warning 3	Unsigned16	ro		
		04h	Warning 4	Unsigned16	ro		
		05h	Warning 5	Unsigned 6	ro		

Table 6.3: Manufacturer-Specific Objects

6.4 Network Management (NMT) commands

To switch between the encoders states (STOPPED, PRE-OPERATIONAL, OPERATIONAL) or to trigger a soft reset, there are different NMT commands. The messages are 3 bytes each and will not be acknowledged. The CAN-ID of the NMT is always ZERO and therefore has the highest priority.

0	02h	Command	Node-ID
CAN-ID	DLC	Byte 0	Byte 1

Node-ID:

The node-ID determines, if the NMT will address a certain node or all nodes.

Node	Designated value
All Nodes	00d
Valid node-IDs	01..127d
Invalid node-IDs	128..255d

Command:

The command determines the intended reaction of the addressed node.

NMT command	Value
Start node	01h
Stop node	02h
Pre-Operational	80h
Reset node	81h
Reset communication	82h

6.5 Heartbeat Protocol

By default the heartbeat protocol is disabled.

The encoder can either send a heartbeat (producer heartbeat) or monitor the heartbeat of other nodes (consumer heartbeat):

Producer heartbeat (Encoder sends its heartbeat)

The producer heartbeat can be enabled by setting the producer heartbeat time in milli-seconds and may be disabled by setting the producer heartbeat time to 00h. This is done by object 1017h, sub-index 0 (00h=OFF, time in milli-sec.= 0..9999h).

Consumer Heartbeat (Encoder monitors an external heartbeat)

The object 1016h, sub-Index=01h, defines the consumer heartbeat time. The encoder uses this time to monitor an-

other heartbeat producer. If the monitored heartbeat does not occur within this time (e.g. device broken), the encoder sends an EMCY message with error code 8130h (Life guard or heartbeat error). The object also defines the node-ID to be monitored.

Bit 31 -24	Bit 23 -16	Bit 15 -0
Reserved (00h)	Node-ID	Heartbeat producer time

A time value of 0 or a node value 0 or higher than 127 disables the function.

Example for monitoring the node 127d =7Fh with a heartbeat consumer time of 1000 milli-sec (=2710h). An EPC absolute encoder with CANopen interface is assumed to be node 1.:

601h	8	23h	16h	10h	01h	10h	27h	7Fh	00h
CAN-ID	DLC	Com- mand	Object	Object	Sub-	Time	Time	Producer	res.
			L	H	index	L	H	node-ID	

6.6 Emergency Messages (EMCY)

An emergency is sent when a failure occurs either on the bus or within the device. Within an EMCY message the error is coded.

Object 1014h defines the COB-ID of the emergency message. The default value is 80h + device node-ID (1 -127). BasicCAN Frames or ExtendedCAN Frames can be used (Bit 29 = 1).

General structure of an emergency message:

80h+ID	8	Error code L	Error code H	Error reg.	Info 1	Info 2
CANID	DLC	Byte 0	Byte 1	Byte 2	Byte 3	Byte 4

Error	Description
0000h	No error
1000h	Generic error
4200h	Temperature out of tolerance

5000h	Hardware failure
5010h	Single turn failure
5020h	Multi-turn failure
6000h	Software failure
6010h	Software reset
8110h	CAN overrun
8120h	CAN Error passive state
8130h	Heartbeat error
8140h	Bus Off recovery

Table 6.6: Emergency Error Code List

Error register:

Interpretation of object 1001h (bit interpretation, default = 00000000):

Bit:	7	6	5	4	3	2	1	0
Info:	Generic error	co	co	Temperature	Communication	co	co	Specific 2001h
Info:	Specific >2001h	co	co	Communication	Temperature	co	co	Generic error

Error register:

Interpretation of object 1001h (assignment bit -meaning, standard = 00000000):

Bit:	7	6	5	4	3	2	1	0
Info:	co	co	co	Communication	Temperature	co	co	EEPROM error

List info field:

The info field depends on the ErrorCodes:

ErrorCode	Field	Activated bit	Hex-value	Error description
4200h	Info field 1 (Byte 3)	6	40h	Temp. Read Error
		5	20h	Low limit exceeded
		4	10h	High limit exceeded

Error Code	Field	Activated bit	Hex-value	Error description
5000h	Info field 2 (Byte 4)	0	01h	EEProm error in init-phase
		3	08h	EEProm Write-Timeout

Error Code	Field	Activated bit	Hex-value	Error description
8120h + 8100h	Info field 1 (Byte 3) Low Nibble	0	1h	Active, no error
		1+2	6h	Bus Warning
		0+1+2	7h	Bus-passive
8120h + 8100h	Info field 1 (Byte 3) High Nibble	0	1h	Bit
		1	2h	Stuffing error
		0+1	3h	Form
		2	4h	CRC
		0+2	5h	Ack

The low nibble describes the CAN state, the high nibble gives further information about the error.

The transmission of EMCY messages can be disabled by setting bit 31 (MSB) in object 1014h-00h.

By changing 1015h a minimum pause between two EMCYs can be defined (in 100ms steps).

6.7 Error Objects

6.7.1 Manufacturer Status Register

Interpretation of object 1002h (assignment bit -meaning, standard = 00h):

Bit:	7	6	5	4	3	2	1	0
Info:	co	co	co	co	co	EEPROM*	MT*	ST*(1)

Bit:	15	14	13	12	11	10	9	8
Info:	ST*(8)	ST*(7)	ST*(6)	ST*(5)	ST*(4)	ST*(3)	MT*(2)	ST*(1)

Bit:	23	22	21	20	19	18	17	16
Info:	ST*(15)	ST*(14)	ST*(13)	ST*(12)	ST*(11)	ST*(10)	ST*(9)	ST*(8)

Bit:	31	30	29	28	27	26	25	24
Info:	MT*(9)	MT*(8)	MT*(7)	MT*(6)	MT*(5)	MT*(4)	MT*(3)	MT*(2)

*= Error type(number)

6.7.2 Alarms

Interpretation of object 6503h (assignment bit -meaning, standard = 0000000000000000):

Bit:	15	14	13	12	11	10	9	8	7	6	5	4	3	2	1	0
Info:	co	co	co	co	co	co	co	co	co	co	co	co	co	co	co	Position Error

6.7.3 Warnings

Interpretation of object 6505h (assignment bit -meaning, standard = 0000000000000000):

Bit:	15	14	13	12	11	10	9
Info:	co	Temperature read failed	Under temperature	Over temperature	co	co	co

Bit:	8	7	6	5	4	3	2	1	0
Info:	co	co	co	co	co	co	co	co	Frequency limit

6.8 Electronic Cam Switch (CAM)

EPC absolute encoders with CANopen interface provide the ability to configure an electronic cam switch with 8 cams in one single channel. Every cam is defined by its low and high limit, the hysteresis, and the polarity.

6.8.1 CAM-State-Register

The cam state register (object 6300h) represents the state of the 8 cam switches, one bit per cam.

For example the cam state register has the value of 89h:

Position	n 7(MSB)	6	5	4	3	2	1	0(LSB)
Type	CAM 8	CAM 7	CAM 6	CAM 5	CAM 4	CAM 3	CAM 2	CAM 1
Value	1	0	0	0	1	0	0	1
Logic	High	Low	Low	Low	High	Low	Low	High

This means that the cams 1, 4 and 8 are high and the rest are low. If, for example, the cam 4 toggles to low due to the change of the position value, the cam state register would become 81h:

Position	n 7(MSB)	6	5	4	3	2	1	0(LSB)
Type	CAM 8	CAM 7	CAM 6	CAM 5	CAM 4	CAM 3	CAM 2	CAM 1
Value	1	0	0	0	0	0	0	1
Logic	High	Low	Low	Low	Low	Low	Low	High

The cams are independent to each other so the cam state register can take on 256 combinations to control a machine.

6.8.2 CAM-Enable-Register

Each cam can separately be enabled or disabled by the object 6301h sub-Index 01h. The cams are represented by the bits of the object, 1 = ON, 0 = OFF. E.g. CAM 2, CAM 4 and CAM 7 shall be enabled. This results in the following configuration:

Value	0	1	0	0	1	0	1	0
Type	CAM 8	CAM 7	CAM 6	CAM 5	CAM 4	CAM 3	CAM 2	CAM 1

Position	n 7(MSB)	6	5	4	3	2	1	0(LSB)
-----------------	----------	---	---	---	---	---	---	--------

This means writing 4h to object 6301h sub-index 01h. The cams 2, 4 and 7 are now enabled and can switch depending on their configured limits and the position value.

6.8.3 CAM-Polarity-Register

The cam-polarity register object 6302h sub-index 01h alters the polarity of the corresponding cam states in cam state register. By default all cams are high (=1b) when the position value is within the limits of the cam.

E.g. If the cam polarity register is set to 13h (=00010011b) the cams 1, 2 and 6 are inverted.

Position	n 7(MSB)	6	5	4	3	2	1	0(LSB)
Type	CAM 8	CAM 7	CAM 6	CAM 5	CAM 4	CAM 3	CAM 2	CAM 1
Value	0	0	0	1	0	0	1	1
Logic	Default	Default	Default	Inverted	Default	Default	Inverted	Inverted

6.8.4 CAM-Low-Limit



The object CAM-Low-Limit sets the lower switching position for a cam. Each cam has its own CAM-low-limit object. (see object dictionary 6310h...6317h). Within the low-limit objects the subindex represents a cam channel. EPC absolute encoders with CANopen interface provide one channel with 8 cams.

6.8.5 CAM-High-Limit



The CAM-High-Limit defines the upper switching position for a cam, similar to the cam-low-limit. Therefore each cam has its own high-limit-object (see object dictionary 6320h .. 6327h).

The CAM-High-Limit must always be lower than the corresponding low-limit. Therefore the high-limit must be usually configured before the corresponding low-limit.

6.8.6 CAM-Hysteresis

The CAM-Hysteresis defines the width of the cam hysteresis for each single cam (see object dictionary 6320h...6327h).

6.9 Device Profile

Object 1000h provides the number of the implemented device profile and the device type:

0001 0196h -Single turn encoder DS-406 device profile

0002 0196h -Multi-turn encoder DS-406 device profile

6.10 SYNC

1005h is the selected COB-ID on which the encoder awaits the SYNC message. BasicCAN frames and extendedCAN frames (Bit 29 = 1b) are supported. The encoder is a SYNC consumer, not a producer!

6.11 Encoder Designation

Object 1008h returns the encoder designation.

MA SERIES-ST-CO = Singleturn CANopen

MA SERIES-MT-CO = Multiturn CANopen

6.12 Error Behavior

On a CAN communication error an OPERATIONAL encoder switches into PRE-OPERATIONAL status. By editing object 1029h sub-index 01h this behavior can be changed:

Value	Description
00h	Default behavior, go PRE-OPERATIONAL
01h	Do not change current NMT state
02h	Go STOPPED

6.13 NMT Startup Behavior

Index 1F80h determines the encoders NMT-startup behavior: There are 3 options:

Value	Description
00h	Default behavior, go PRE-OPERATIONAL
02h	Send NMT-command "Start All Nodes"
08h	Go "OPERATIONAL" change

By sending a "start all nodes" the encoder take the role of a basic NMT-master. The configuration has to be saved into the EEPROM.

6.14 Bus-Off Auto-Reset

Index 2103h determines the encoder's bus-off behavior. The value defines the time in seconds that elapses before the unit automatically switches on CAN Bus-Off in CAN-Error-Active. The value 0 is the default setting and turns off this behavior.

6.15 Customer Data

The object 2120h provides the possibility to store up to 8 data objects (4 bytes per object) to the internal EEPROM. Each data object is accessed by a sub-index (1...8). The data is stored autonomously; a "save" command is not necessary.

6.16 Temperature

The 2500h provides the current internal temperature of the encoder, as well as the possibility to set temperature limits for the device. Sub-indices 0 to 5 are supported. The temperature value is updated every minute. The unit is °C. Crossing the temperature limits will set the error register (object 1001h-00h) to 1000b (=08h) and trigger a non-recurring EMCY message. The warning object (6505h) will also be affected. By default the limits are set on the maximum values allowed, but can be tightened.

6.17 Verify Configuration

You can write the time of the last valid configuration into object 1020h. This object is also readable. Any change in the configuration will automatically reset this object to zero. Then the new time of configuration can be set.



All change in parameters, unless otherwise specified, have to be saved into the EEPROM by using the “Store All Parameters” command (see 7.11 “Saving settings in the EEPROM”). Otherwise after a reset the encoder will return to the last configuration saved.

7.Connection

7.1 Mechanical and Electrical Connection



Please refer to the included mounting instructions and information for proper mechanical and electrical connections.

Shaft encoders:

Always use a suitable coupling to connect the encoder shaft with the application shaft. The coupling compensates the radial and axial tolerances of both shafts. Both shafts must not touch each other. Please observe the maximum permitted shaft load. Suitable accessories can be found on www.encoder.com.

Use the threaded bores to screw the encoder flange onto a suitable mounting.

Another possibility for mounting is the use of servo clamps.

Blind hollow bore encoders:

Mount the encoder completely onto the application shaft. Use the set screw to tighten the encoder shaft to the application shaft.

The flexible mount absorbs vibrations and tolerances of the application shaft to reduce stress on the encoder bearings and must be affixed to the application frame.



Definition:	Wire color (Encoder with cable)	Pin (Encoder with connector)
+VDC (10-30V)	brown	2
Ground (GND)	white	3
CANHigh	green	4
CANLow	yellow	5
CANGND	grey	1

Table 7.1: Pin and Cable Assignment (according to CiA 303)

7.2 Configuration via LSS

7.2.1 General Settings

The Layer Setting Services Protocol is specified in the Draft Standard Proposal 305. The LSS allows to configure the encoder even when the node ID is not assigned correctly (i.g. the default node ID doesn't match the application before configuration). EPC absolute encoders with CANopen interface provide the following LSS services:

Switch state global

Switch state selective

Configure baudrate service

Configure node-ID service

Store configuration service

Identification and inquire services (Node-ID, Vendor-ID, ProductCode, RevisionNumber, SerialNumber)

To use LSS the encoder has to be **STOPPED or PRE-OPERATIONAL**. Then the encoder can be set into LSS mode by two ways:

Switch Mode Global

Switch Mode Selective

An LSS message has the following form:

CAN-ID	DLC	Com- mand	Byte 0	Byte 1	Byte 2	Byte 3	Byte 4	Byte 5	Byte 6
--------	-----	--------------	--------	--------	--------	--------	--------	--------	--------

For the CAN-ID applies:

LSS-Master LSS-Slave: 2021(7E5h)

LSS-Slave LSS-Master: 2020(7E4h)

The command byte determines the interpretation of the following bytes 0 - 6.

Connection of the encoder and start LSS configuration by "Switch Mode Selective":

Connect the encoder to the LSS master. If possible, start encoder before the master. The baudrate used by the master will be detected by the encoder. Use the NMT command to switch the encoder into "STOPPED" mode. With the switch mode selective a certain device can be selected by sending four identification messages:



LSS-Command	Information	Description
40h	Vendor-ID	0100 021Fh
41h	ProductCode	5743 4741h
42h	RevisionNumber	Revision of the encoders
43h	SerialNumber	Serial number of the encoder

Table 7.2.1: LSS-Selective-Identification-Commands

Detailed information about revision number and serial number can be found in **Section 1.1**.

After the last of the four identification messages was sent, the appendant encoder will respond with:

LSS-Command	Information	Description
44h	Mode	Mode = 1 → Config mode; Mode = 0 → Operations mode

The encoder is now in configuration mode. Now you can set the encoder's baudrate and node ID using LSS (see **Section 7.2**).

Connection of the encoder and start LSS configuration by "Switch Mode Global":



Connect the LSS master with the encoder. If possible start encoder before the master. The baudrate used by the master will be detected by the encoder. Use the NMT command to switch the encoder into "STOPPED" mode. Send the message:

7E5h	04h	01h	00h	00h	00h	00h	00h	00h
------	-----	-----	-----	-----	-----	-----	-----	-----

Now the encoder is in configuration mode and you can set the encoder's baudrate and node ID using LSS (see **Section 7.2**).



As soon as the encoder has entered the LSS config mode (selective or global) baudrate and node ID can be changed by LSS. After changing, the settings have to be stored and the config mode has to be deactivated. (See below, "End LSS configuration mode").

End LSS configuration mode:

When the configuration is completed the changed parameters must be stored and the encoder switched into PRE-OPERATIONAL state. To do so, use the following message sequence and a final reset (e.g., a power reset):



Step 1 – store parameters:

7E5h	17h	00h	00h	00h	00h	00h	00h	00h
------	-----	-----	-----	-----	-----	-----	-----	-----

Step 2 – Leave config mode:

7E5h	04h	00h	00h	00h	00h	00h	00h	00h
------	-----	-----	-----	-----	-----	-----	-----	-----

Step 3 – Reset

7.2.2 Baudrate Setting

To set the baudrate send the following command:

7E5h	13h	00h	Baudrate	00h	00h	00h	00h	00h
CAN-ID	Command	Sub-Index	Baudrate	Byte 2	Byte 3	Byte 4	Byte 5	Byte 6

The following baudrates can be selected:

Value	Baudrate
0	1 MBit/s
1	800 kBit/s
2	500 kBit/s
3	250 kBit/s
4	125 kBit/s
5	100 kBit/s
6	50 kBit/s
7	20 kBit/s
8	10 kBit/s
9	Baudrate-Auto-Detection

Table 7.2.2: Baudrate-Coding

Check the LSS slaves answer to the command above:

7E4h	13h	00h	00h	00h	00h	00h	00h	00h
CAN-ID	Command	Error	Specific	Byte	Byte	Byte	Byte	Byte

		code	Error	2	3	4	5	6
--	--	------	-------	---	---	---	---	---

With Error code:

00h = OK

01h = Baudrate not supported

With Specific Error:

00h = OK

FFh = Application specific error

It is possible that after the configuration the communication with the encoder fails because the configuration tool and the encoder might operate on different baudrates, so you have to change the baudrate configuration of your tool.



Before changing the baudrate you have to check the baudrate of the application. Make certain your configuration tool supports that baudrate. Make a note of the selected baudrate (e.g., in this manual or on the encoder label).

7.2.3 Node ID Setting

Use the following command to change the encoders node ID:

7E5h	11h	New Node-ID	00h	00h	00h	00h	00h	00h
CAN-ID	Command	Node-ID	Byte 1	Byte 2	Byte 3	Byte 4	Byte 5	Byte 6

Valid Node IDs are 01h to 7Fh.

7.3 Configuration via SDO

7.3.1 Reading and Writing on Objects

You can use SDO communication to read or write on objects. **Read access on an object:**

The structure of an SDO message is:

Client (master) to server (encoder) :

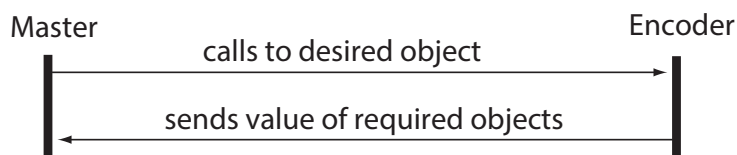

600h+ID	8	40h	04h	60h	00h	00h	00h	00h	00h
CAN-ID	DLC	Com- mand	Object L	Object H	Sub- Index	Byte 0	Byte 1	Byte 2	Byte 3

The payload of the SDO is 4 bytes of data (d1d2d3d4):

580h+ID	8	43h	04h	60h	00h	d4	d3	d2	d1
CAN-ID	DLC	Com- mand	Object L	Object H	Sub- Index	Byte 0	Byte 1	Byte 2	Byte 3

Command	Type	Description
22h	Write command	Parameter to encoder
23h	Write command	4 Byte Parameter to encoder
27h	Write command	3 Byte Parameter to encoder
2Bh	Write command	2 Byte Parameter to encoder
2Fh	Write command	1 Byte Parameter to encoder
60h	Acknowledge	Parameter received
40h	read command	Parameter from Encoder

42h	response	Parameter to SDO master
43h	response	4 Byte Parameter to SDO master
47h	response	3 Byte Parameter to SDO master
4Bh	response	2 Byte Parameter to SDO master
4Fh	response	1 Byte Parameter to SDO master
80h	abort code	Failure / Failure code
41h	response	SDO segmented transfer started (see CiA 301)

Table 7.3.1: Command Definitions

Writing on an object:

The following example shows the structure of a SDO telegram.

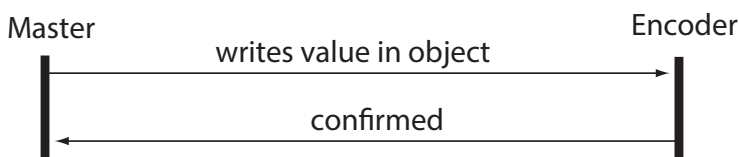

Master sends 1 byte of data (d1) to the Encoder:

600h+ID	8	2Fh	00h	21h	00h	d1	00h	00h	00h
CAN-ID	DLC	Com- mand	Object L	Object H	Sub- Index	Byte 0	Byte 1	Byte 2	Byte 3

The encoder acknowledges without data bytes:

580h+ID	8	2Fh	00h	21h	00h	00h	00h	00h	00h
CAN-ID	DLC	Com- mand	Object L	Object H	Sub- Index	Byte 0	Byte 1	Byte 2	Byte 3

7.3.2 Baudrate Selection

EPC's absolute encoders with CANopen interface provide an automatic baudrate detection. It is also possible to use a fixed baudrate which can be set by either LSS (as described above) or SDO.

The configuration of the encoder is only possible in PRE-OPERATIONAL state. To alter the baudrate, change the object **2100h** in Sub-Index 00h.

This can be achieved with a simple SDO write command with the target baudrate as data.

600h+ID	8	2Fh	00h	21h	00h	Baudrate	00h	00h	00h
CAN-ID	DLC	Com- mand	Object L	Object H	Sub- Index	Byte 0	Byte 1	Byte 2	Byte 3

The following values represent the valid baudrates:

Value	Baudrate
0	1 MBit/s
1	800 kBit/s
2	500 kBit/s
3	250 kBit/s
4	125 kBit/s
5	100 kBit/s
6	50 kBit/s
7	20 kBit/s
8	10 kBit/s
9	Baudrate-Auto-Detection

Table 7.3.2: Baudrate Codes



The new baudrate will become effective after a reset of the encoder (hard reset or NMT reset). Writing on object 2100h is not protected and the change will be immediately stored in the internal EEPROM. It is not necessary to perform a "save parameters".

7.3.3 Node-ID Election

It is possible to change the node ID of the encoder by SDO. To set the node ID the object **2101h**, sub-Index 00h, has to be changed (only possible in PREOPERATIONAL state!) with a simple SDO write command:

600h+ID	8	2Fh	01h	21h	00h	Node	00h	00h	00h
CAN-ID	DLC	Com- mand	Object L	Object H	Sub- Index	Byte 0	Byte 1	Byte 2	Byte 3

Valid node IDs can be:

Encoder number (d)	Node-ID (h)
1	01h
2	02h
...	...
127	7Fh



The new node ID will become effective after an encoder reset (hard reset or NMT reset). Writing on object 2101h is not protected and the change will be immediately stored in the internal EEPROM. It is not necessary to perform a "save parameters".

7.3.4 Basic NMT Commands

To set the encoder into **OPERATIONAL state**, the "Start remote node" command is used:

0	02h	01h	0 to 127
CAN-ID	DLC	Command Byte	Node-ID

To change the encoder into **STOPPED state**, the "Stop remote node" command is used:

0	02h	02h	0 to 127
CAN-ID	DLC	Command Byte	Node-ID

To switch the encoder into **PRE-OPERATIONAL state**, the “Enter Pre-Operational State” command is used:

0	02h	80h	0 to 127
CAN-ID	DLC	Command Byte	Node-ID

A **Reset of communication** with a change into PRE-OPERATIONAL after re-initialization will be achieved

0	02h	82h	0 to 127
CAN-ID	DLC	Command Byte	Node-ID

To perform a soft reset of the encoder, the “Reset Remote Node” is used. After the reset the encoder will send this boot-up message and enter PREOPERATIONAL by default:

0	02h	81h	0 to 127
CAN-ID	DLC	Command Byte	Node-ID

7.4 Heartbeat Settings

To configure and start the producer heartbeat (e.g. heartbeat every 5000 milliseconds; 5000d=1388h) use SDO on object 1017h:

600h+ID	8	2Fh	17h	10h	00h	88h	13h	00h	00h
CAN-ID	DLC	Com- mand	Object L	Object H	Sub- Index	Byte 0	Byte 1	Byte 2	Byte 3

This is the structure of a heartbeat message:

701h	1	d	NMT-state
CAN-ID	DLC	Data/Remote	Byte 0

NMT-state	Code
Boot-up	00h
Stopped	04h
Pre-Operational	7Fh
Operational	05h

Table 7.4: Heartbeat NMT-State-Coding

7.5 PDO Configuration

7.5.1 PDO Parameters

Up to 4 PDOs can be configured. The configuration of the PDO payload is called “PDO mapping”. The defaults values are shown below:

Object	PDO	Configuration (Scheduling)	“mapped” Process data
1800h	PDO1	Asynchronous / on change of position value	Position value
1801h	PDO2	Synchronous / on every SYNC	Position value
1802h	PDO3	Synchronous / on every SYNC	High precision value
1803h	PDO4	Disabled	

Table 7.5.1A: Default PDO Configuration

There are five different types of transmission for every PDO:

Sub-Index 2	Sub-Index 5	Description
01h-F0h	n.N.	PDO synchronous / on a SYNC
FFh	0000h	PDO disabled
FEh	0001h-FFFFh	PDO asynchronous / triggered by event timer AND change in position value

FEh	0000h	PDO asynchronous / triggered by change of position value
FFh	0001h-FFFFh	PDO asynchronous / triggered by event timer

Table 7.5.1B: Possible PDO Transmission Types



Parameters can be changed in PRE-OPERATIONAL only and have to be saved into EEPROM!

To completely disable a PDO, you have to change the MSB of the PDO-COB-ID object:

PDO	Object	COB-ID object PDO enabled	COB-ID object PDO disabled
1	1800h	40000181h	C0000181h
2	1801h	40000281h	C0000281h
3	1802h	40000381h	C0000381h
4	1803h	40000481h	C0000481h

Table 7.5.1C: PDO Deactivation

For example PDO1 shall be disabled by this SDO write command:

600h+ID	8	23h	00h	18h	01h	81h	01h	00h	C0h
CAN-ID	DLC	Com- mand	Object L	Object H	Sub- Index	Byte 0	Byte 1	Byte 2	Byte 3



Advanced parameterization of the PDO COB-ID (objects 1800h-01h, objects 1801h-01h, objects 1802h-01h, objects 1803h-01h) is possible. As long as no “save communication objects” or “save all parameters” has been performed, a change of the node ID will automatically effect the COB IDs. After a save command, the PDO COB-IDs have to be changed manually or perform a “restore all parameters”.

7.5.2 Synchronous PDO

A PDO can be configured for synchronous transmission, i.e. to respond on a SYNC message. The sub-index 2 of the transmission type parameter determines after which number of SYNCs received the PDO will be transmitted. For example PDO1 is configured 01h in 800h-02h:

600h+ID	8	2Fh	00h	18h	02h	01h	00h	00h	00h
CAN-ID	DLC	Com- mand	Object L	Object H	Sub- Index	Byte 0	Byte 1	Byte 2	Byte 3

Transmission type for PDO1 is now synchronous. In OPERATIONAL state, PDO1 will be sent on every SYNC message.

7.5.3 Asynchronous PDO

Cyclic (triggered by internal event timer):

PDOs can be configured for asynchronous cyclic transmission. Therefore the transmission type in Object 1800h-02h (1801h-02h, 1802h-02h, 1803h-02h) has to be set to FFh. Sub-index 5 of the same object is the cycle time in milliseconds.

I.G. PDO1 transmitting asynchronously cyclic:

600h+ID	8	2Fh	00h	18h	02h	FFh	00h	00h	00h
CAN-ID	DLC	Com- mand	Object L	Object H	Sub- Index	Byte 0	Byte 1	Byte 2	Byte 3

PDO1 with a cycle time of 30 milliseconds (1Eh):

600h+ID	8	2Bh	00h	18h	05h	1Eh	00h	00h	00h
CAN-ID	DLC	Com- mand	Object L	Object H	Sub- Index	Byte 0	Byte 1	Byte 2	Byte 3

PDO1 is now in asynchronous mode and will be sent every 30 milliseconds in OPERATIONAL state.

Triggered by change of position value:

To use this transmission type, sub-index 2 has to be FEh and the event timer in sub-index 5 has to be disabled (00h), e.g.:

600h+ID	8	2Fh	00h	18h	02h	FEh	00h	00h	00h
CAN-ID	DLC	Com- mand	Object L	Object H	Sub- Index	Byte 0	Byte 1	Byte 2	Byte 3

7.5.4 Variable PDO-Mapping

Variable PDO-mapping means that the PDO payload can be configured by the user. This mapping must match between encoder and receiver. The maximum payload for a PDO is 8 bytes. The mapping is also limited by the size of the objects to be mapped. E.g. you can map the “position value” (4 bytes), the “speed value” (2 bytes) and the “acceleration” value (2 bytes) into the same object. Due to the fixed size of a CAN frame this produces less bus load than transmitting the three objects by 3 individual PDOs. This table shows the PDO mapping:

Data	Object #	Sub- Index	Value	Size	Description
1	6004h	00h	Unsigned32	4 Byte	Position value
2	6030h	01h	Integer16	2 Byte	Speed value
3	6040h	01h	Integer16	2 Byte	Acceleration value

The data 1, 2, and 3 (See mapping table) are spread over the PDOs 8 payload bytes. The actual payload is 4byte + 2 byte + 2byte = 8 byte. This leads to 100.

The resulting PDO has this structure:

PDO1:

180h+ID	8	1d	1c	1b	1a	2b	2a	3b	3a
CAN-ID	DLC	Byte 0	Byte 1	Byte 2	Byte 3	Byte 4	Byte 5	Byte 6	Byte 7

1a, 1b, 1c, 1d = 4 bytes of information 1; 2a, 2b = 2 bytes of information 2; 3a, 3b = 2 bytes of information 3.



To use the PDO mapping, the mapping parameters for the transmit PDO must be configured (see Method, Table 6. 1 The Object Dictionary).

Delete current mapping

- Remapping the PDO
- Activating the new mapping

For example, to change the PDO1 mapping you have to access the PDO1 mapping parameter object 1A00h.

Delete current mapping

First the sub-index 0 of the Mapping parameter object has to be set to zero:

600h+ID	8	2Fh	00h	1Ah	00h	00h	00h	00h	00h
CAN-ID	DLC	Com- mand	Object L	Object H	Sub- Index	Byte 0	Byte 1	Byte 2	Byte 3

Now the encoder is ready for remapping.

Remapping the PDO

Mapping of the **position value**: (No.:1 (Size 32 bit = 20h) into object 1A00h sub-index 1 for PDO1):

600h+ID	8	23h	00h	1Ah	01h	20h	00h	04h	60h
CAN-ID	DLC	Com- mand	Object L	Object H	Sub- Index	Byte 0	Byte 1	Byte 2	Byte 3

The SDO command contains the object to be mapped and its size: (Object 6004h, sub-index 0, Size 20h = 4 Byte).

Mapping of **speed value** (No.:2 (Size 16 bit = 10h) into object 1A00h sub-index 2 for PDO1):

600h+ID	8	23h	00h	1Ah	02h	10h	01h	30h	60h
CAN-ID	DLC	Com- mand	Object L	Object H	Sub- index	Byte 0	Byte 1	Byte 2	Byte 3

The SDO command contains the object to be mapped and its size: (Object 6030h, sub-index 1, Size 10h = 2 Byte).

Mapping of **Acceleration value** (No.:3 (Size 16 bit = 10h) into object 1A00h sub-index 3 for PDO1):

600h+ID	8	23h	00h	1Ah	03h	10h	01h	40h	60h
CAN-ID	DLC	Com-mand	Object L	Object H	Sub-Index	Byte 0	Byte 1	Byte 2	Byte 3

The SDO command contains the object to be mapped and its size: (Object 6040h, sub-index 1, Size 10h = 2 Byte).

Activating the new mapping

To activate the new mapping, the new number of mapped objects must be written into sub-index 0 of the mapping parameter object. In our example three objects are mapped, therefore sub-index 0 has to be set to 03h.:

600h+ID	5	2Fh	00h	1Ah	00h	03h
CAN-ID	DLC	Command	Object L	Object H	Sub-Index	Byte 0

The remapping of PDO1 is now completed and valid, but it should be saved into the EEPROM (see 7.11).

7.6 Changing Resolution and Direction



To change resolution and direction of the encoder the scaling option has to be activated.

When activating the scaling, you can also change the counting direction – clockwise (CW) or counter-clockwise (CCW) – when looking onto the flange side of the encoder in one step (default setting is CW).

The object for this configuration is 6000h sub-index 00h. Here is the list of possible settings:

Code Byte0	Scaling	Direction
00h	OFF	Clockwise (CW)
01h	OFF	Counter-clockwise (CCW)
04h	ON	Clockwise (CW)
05h	ON	Counter-clockwise (CCW)

Table 7.6: Counting Direction and Scaling Parameters

This is an example how to set the “operating parameters” object 6000h to “scaling ON” and “CCW”:

600h+ID	8	23h	00h	60h	00h	05h	00h	00h	00h
CAN-ID	DLC	Com- mand	Object	Object	Sub-	Byte	Byte	Byte	Byte
			L	H	Index	0	1	2	3

The encoder responds with a standard SDO acknowledge.

Changing the measuring range per revolution and the total measuring range.

- The measuring range per revolution or singleturn resolution is the number of units (bit) per revolution.
- The total measuring range is the singleturn resolution multiplied with the number of countable revolutions (multiturn resolution).

Example:

Singleturn resolution: 4096 bit per revolution = 12 bit = 10 00h

Total measuring range: 536 870 912 units (bit) = 29 bit = 20 00 00 00h

→Max. Multiturn resolution: 29 Bit - 12 Bit = 17 Bit = 131072 revolutions (02 00 00h)

The singleturn resolution editable in object 6001h:

600h+ID	8	23h	01h	60h	00h	00h	10h	00h	00h
CAN-ID	DLC	Com- mand	Object L	Object H	Sub- Index	Byte 0	Byte 1	Byte 2	Byte 3

00 00 10 00h represent the designated single turn resolution. The encoder responds with an SDO acknowledge.

The total measuring range can be changed by object 6002h. In the example a 29 bit total measuring range is selected. With a 12 bit singleturn resolution 17 bit rotations are counted before returning to zero:

600h+ID	8	2Bh	02h	60h	00h	00h	00h	00h	20h
CAN-ID	DLC	Com- mand	Object L	Object H	Sub- Index	Byte 0	Byte 1	Byte 2	Byte 3

20 00 00 00h is the designated total measuring range.

Singleturn resolution and total measuring range do not have to match the bit grid. Every value between 1 and the maximum is valid. The total measuring range can not be less than the singleturn resolution. The result of an invalid setting will be an abort code.

7.7 Position Preset

With object 6003h the encoder position can be shifted to a preset value. E.g. you can set the zero position of your application without time-consuming mechanical alignment. Just mount the encoder and set the preset object 6003h to the designated position value (p1-p4):

600h+ID	8	23h	03h	60h	00h	p1	p2	p3	p4
CAN-ID	DLC	Com- mand	Object L	Object H	Sub- Index	Byte 0	Byte 1	Byte 2	Byte 3



To set the zero position: p1, p2, p3, p4 = 00h, 00h, 00h, 00h

You don't have to use PDOs to check the current position value. You can also perform a SDO read access on the position value object 6004h:

600h+ID	8	40h	04h	60h	00h	00h	00h	00h	00h
CAN-ID	DLC	Com- mand	Object	Object	Sub- Index	Byte	Byte	Byte	Byte
			L	H	Index	0	1	2	3

The encoder will respond with the current position value.

The encoder provides internal filtering for the position value. Sub-index 1 of object 2105h is the filter parameter for the internal "IIF"-filter (infinite impulse response filter). 01h for the filter parameter deactivates the filter. The maximum value is 04h. A filtered position value is more stable at the cost of less dynamic.

7.8 Change Speed-Integration and Speed Scaling

The **integration time** the encoder uses to calculate the speed value can be adjusted by object 2105h, sub-Index 2. The unit for this time is milliseconds. The default value of 1000 ms is suitable for most applications.

The change of the integration time will result in a more or less dynamic behavior of the speed value, similar (but independent) to the filtering of the position value.

The **speed scaling** can be edited by object 2106h. The Sub-Indices 1 (= numerator) and 2 (= denominator) form a scaling factor (here: "z") for the speed scaling. Default value is "1". The speed value is always given in Increments/sec.

Object 2106h is a signed 16 value with the limits of ± 32767 representing ± 120 rotations per second. For example the speed shall be scaled to a maximum of ± 2500 rpm :

$z = \text{Scaling factor } z = \frac{k}{n}$

$n = \text{Max rotation per sec } z = \frac{120}{2500}$

$k = \text{Calculation factor} = 120 \quad z = \frac{6}{125}$

So object 2106h-01h must be set to 6d = 06h and 2106h-02h set to 125d = 7Dh, so the limits of ± 32767 are scaled to ± 2500 U/min

Applying this scaling, the limits ± 32767 corresponds with ± 2500 rpm.

7.9 Frequency Limit

If the speed value exceeds the frequency limit 2107h a warning flag is set (no EMCY). The valid area is 1 to 65535 representing the maximum allowed rotation speed (i.g. 2520 rpm = 42 rotations per second = 002Ah as frequency limit).

7.10 CAM-Configuration

This section gives an example how to configure the cam-channel:

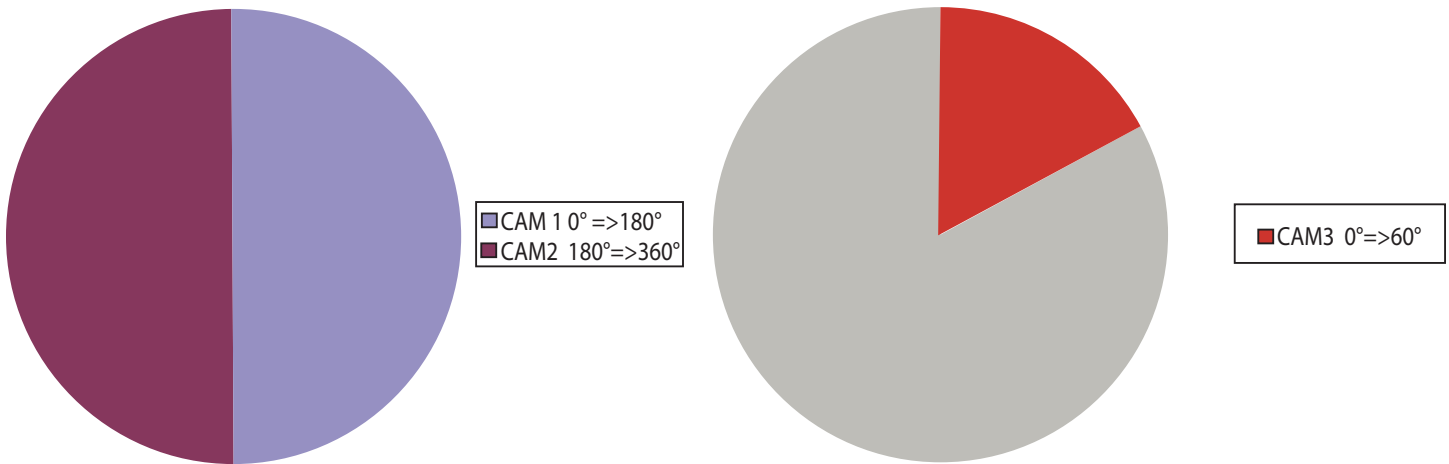

For the individual cams, this means:

CAM	Angular area	Lower CAM-limit	Upper CAM-limit	Hysteresis
1	0°..180°	0d	2048d	0d
2	180°..360°	2049d	4095d	0d
3	0°.. 60°	0d	682d	0d



The configuration must be done in PREOPERATIONAL state.

To enable the individual cams the CAM-enable-register (object 6301h-01h) is used. The setting 00000111b = 07h enables the first three cams.

600h+ID	5	2Fh	01h	63h	01h	07h	00h	00h	00h
CAN-ID	DLC	Com-mand	Object L	Object H	Sub-Index	Byte 0	Byte 1	Byte 2	Byte 3

Now the cam-high-limits 1, 2, and 3 can be set as in the table above:

CAM 1 = 2048 = 0800h

600h+ID	8	23h	20h	63h	01h	80h	00h	00h	00h
CAN-ID	DLC	Com- mand	Object L	Object H	Sub- Index	Byte 0	Byte 1	Byte 2	Byte 3

CAM 2 = 4095 = 0FFFh

600h+ID	8	23h	21h	63h	01h	FFh	0Fh	00h	00h
CAN-ID	DLC	Com- mand	Object L	Object H	Sub- Index	Byte 0	Byte 1	Byte 2	Byte 3

CAM 3 = 682 = 02AAh

600h+ID	8	23h	22h	63h	01h	AAh	02h	00h	00h
CAN-ID	DLC	Com- mand	Object L	Object H	Sub- Index	Byte 0	Byte 1	Byte 2	Byte 3

The setting of the CAM-Low-Limits 1, 2 und 3 is similar:

CAM 1 = 0 = 00h

600h+ID	8	23h	10h	63h	01h	00h	00h	00h	00h
CAN-ID	DLC	Com- mand	Object L	Object H	Sub- Index	Byte 0	Byte 1	Byte 2	Byte 3

CAM 2 = 2049 = 0801h

600h+ID	8	23h	11h	63h	01h	01h	08h	00h	00h
CAN-ID	DLC	Com- mand	Object L	Object H	Sub- Index	Byte 0	Byte 1	Byte 2	Byte 3

CAM 3 = 0 = 00h

600h+ID	8	23h	12h	63h	01h	00h	00h	00h	00h
---------	---	-----	-----	-----	-----	-----	-----	-----	-----

CAN-ID	DLC	Com- mand	Object L	Object H	Sub- Index	Byte 0	Byte 1	Byte 2	Byte 3
--------	-----	--------------	----------	----------	---------------	--------	--------	--------	--------

In our example the CAM-Hysteresis shall be 0, so there is no change necessary.

With the CAM-Polarity-register the polarity of the cams can be inverted.

After configuration, the state of the cams can be read from the CAM-state register 6300h-01. This object is also PDO mappable. For more details see **Section 6.8**.

Be sure to save the configuration into the EEPROM. See **Section 7.11**.

7.11 Saving Into EEPROM

Non-volatile storing of parameters using object 1010h.

Sub-Index	Access mode	Description
0	co	Number of objects
1	wo	Save all parameters
2	wo	Save communication Objects
3	wo	Save application Objects
4	wo	Save manufacturer Objects

To start the storing operation the "ASCII" value for "save" (in hex: 73h 61h 76h 65h) has to be written into the dedicated sub-index.

"Save all Parameters":

600h+ID	8	23h	10h	10h	01h	73h	61h	76h	65h
CAN-ID	DLC	Com- mand	Object L	Object H	Sub- Index	Byte E	Byte V	Byte A	Byte S

Restoring default settings

To restore the default settings the “ASCII” value “load” (in hex: 6Ch 6Fh 61h 64h) is written on the dedicated sub-index of the object 1011h.

Sub-Index	Access	Description
0	co	Number of objects
1	wo	Restore all parameters
2	wo	Restore communication Objects
3	wo	Restore application Objects
4	wo	Restore manufacturer Objects



Attention: The baudrate and node-ID settings, as well as the customer data object will not be restored!

8. Troubleshooting

Error description	Check
Encoder doesn't work, the LED stays dark.	Check connections, power supply, and pin assignment.
Encoder does not work but is properly connected	Connect a CAN Monitoring-tool, determine if the host sends a boot-up message when starting.
Unable to connect to host	Check the encoder for correct node ID and baudrate.
The bus load exceeds 85. After connection the encoder goes bus-passive or bus-off immediately.	Check baudrate and node IDs of all nodes connected.
There are irregular failures during transmission.	Check the correct termination (2 Terminations, 120 Ohms each, one at each end).

©2020 Encoder Products Company. All rights reserved.

Encoder Products Company

464276 Highway 95 South

Sagle, Idaho 83860

USA

Tel: (208) 263-8541

Fax: (208) 263-0541

E-mail: support-epcmag@encoder.com

Website: encoder.com