



Installation and Wiring Guide



ACCU  **CODER**
by Encoder Products Company

Precision Products for Every Application

**EPC World Headquarters
Americas Division**
464276 Highway 95 South
P.O. Box 249
Sagle, ID 83860-0249 USA

Phone: 800-366-5412
208-263-8541
Fax: 208-263-0541
E-mail: sales@encoder.com
Website: encoder.com

EPC- Your Encoder Solutions Partner

Company History

Encoder Products Company Inc. (EPC) is a leading designer and world-wide manufacturer of motion sensing devices. Founded in 1969 by William Watt, EPC began operations with a small line of custom encoders. Today, 50 years later, EPC's popular Accu-Coder™ brand is the most complete line of incremental and absolute shaft encoders in the industry. Our core philosophy is that each and every customer deserves quality products, superior customer service, and expert support.

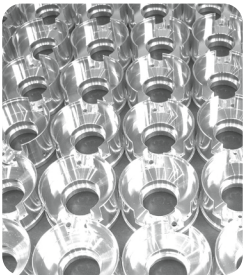

Leading The Industry By Innovation

Concentrating specifically on encoders, we have paved the path of the encoder industry, providing many of the current encoder standards. Our industry leading advancements include the Cube style encoder, flex-mount system used on hollow-bore encoders, Opto-ASIC technology for enhanced signal quality, 120° C operating temperature for extreme environments, 6000 CPR in a 1.5" diameter encoder, a three year standard warranty, and many others.

Custom Encoders Our Specialty

Through years of experience, we understand each industrial environment is different, and customize encoders for your specific situations. Many of our customers depend on EPC to provide encoders which fit their specifications, not someone else's. Using state of the art technology, we can design and deliver custom encoders faster than most suppliers standard products - often shipping your unique encoder in 2 to 6 days, or sooner. Plus, with ISO 9001:2015 quality systems, you will receive the quality you deserve.



TABLE OF CONTENTS

Warranty Information	1
Encoder Basics	2
Accessories	3
Mounting and Mechanical Installation	4
Recommended Bolt Torques	5
Electrical Connection.....	6
Output Circuit Diagrams.....	8
Incremental Encoder Wiring Tables.....	9
Absolute Encoder Wiring Tables	12
Troubleshooting.....	13

Congratulations on your purchase of a genuine EPC Accu-Coder™ brand encoder. Every Accu-Coder™ is built to exact standards, and thoroughly tested during the manufacturing process. Improper installation is the major cause of most common problems. By following the guidelines given in this pamphlet, we hope to eliminate any problems before they start, thus providing the maximum life from your encoder. Properly installed and cared for, your Accu-Coder™ will give you years of trouble free use.

Technical Bulletins, which provide general encoder information, and cover specific installations, can be found on **encoder.com**. If you have any questions concerning installation, please feel free to call Customer Service at 1-800-366-5412. **Thank you!**

WARRANTY INFORMATION

Your Accu-Coder™ is guaranteed against defects in materials, and workmanship by the best three year standard warranty in the business. The warranty applies to all standard catalog products starting three years from the date of shipment. To learn more about our three year standard warranty, go to **encoder.com**.

ENCODER BASICS

Encoders provide motion control systems information on position, count, speed, and direction. As the encoder shaft rotates, output signals are produced, proportional to the distance (angle) of rotation. The signal may be in the form of a square wave (for an incremental encoder) or an absolute measure of position (for an absolute encoder).

Due to the performance and reliability advantages of the semi-conductor technology they incorporate, optical encoders are the preferred solution in many common computer, industrial, and automotive applications. Optical encoders also benefit from ease of customization, are suitable to numerous environments, and suffer no effects from high levels of stray magnetic fields.

The basic construction of an incremental encoder is shown to the right. A beam of light emitted from an LED passes through a transparent disk patterned with opaque lines, and is picked up by a photodiode array. The photodiode array (also called a photosensor) responds by producing a sinusoidal waveform which is transformed into a square wave, or pulse train.

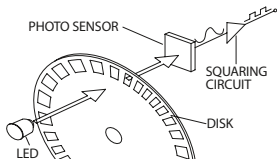







Incremental encoders are available in two basic output types, single channel and quadrature. A single channel encoder, often called a tachometer, is normally used in systems that rotate in one direction only, and require simple position and velocity information. Quadrature encoders have dual channels (A and B), phased 90 electrical degrees apart. These two output signals determine the direction or rotation by detecting the leading or lagging signal in their phase relationship. Quadrature encoders provide very high speed bi-directional information for very complex motion control applications.

Incremental encoders can provide a once-per-revolution pulse (often called index, marker, or reference) that occurs at the same mechanical point of encoder shaft revolution. This pulse is on a separate output channel (Z) from the signal channel or quadrature outputs. The index pulse is often used to position motion control applications to a known mechanical reference.

Resolution is a term used to describe the Cycles Per Revolution (CPR) for incremental encoders, or the total number of unique positions per revolution for an absolute encoder. Each incremental encoder has a defined number of cycles that are generated for each full 360 degree revolution. These cycles are monitored by a counter or motion controller and converted to counts for position or velocity control. Absolute encoders generate a unique code word for every resolvable shaft angle (often called bits or counts per revolution).

ACCESSORIES

Accessory items are often the difference between an installation that goes smoothly, and one that does not. EPC offers a range of accessories that are designed to not only make your life easier, but are manufactured to EPC's high standards, ensuring years of trouble free service. In addition, they have been tested with the products they complement, so that you do not have to worry about proper form, fit, or function.

	Connectors/Cables High quality connectors, cables, cable assemblies, and cord sets selected to optimize encoder performance; most can be ordered with MS style or M12 connectors.
	Shaft Couplings Precision shaft couplings to optimize performance and reduce the chance of premature failure; designed to restrict the transfer of thermal and mechanical stress; wide range of choices to match your exact requirement. Call about our new Magnetic Coupling!
	Protective Covers Covers help protect encoders from damage. They also allow a wider variety of encoders to be used in harsh environments.
	Hub/Flanges Allow Accu-Coder™ encoders to be easily mounted to industry standard housing styles; NEMA, servo, 5PY, and other styles available; rugged, reliable construction.
	Mounting Brackets Used to mount measuring wheels to Cube and 702 Series Accu-Coders™. Two types: single pivot and dual pivot; single pivot pivots vertically while dual pivot pivots vertically and longitudinally.
	Measuring Wheels Used to obtain linear motion feedback from a rotating shaft; range of surface finishes (urethane, rubber, knurled, grooved) for proper mating to nearly any application surface; available in several sizes to allow you to satisfy your exact requirements.
	Linear Cable Adapter The linear cable adapter (LCA) used with a Cube Series standard or industrial housing, provides a low cost alternative for obtaining accurate linear measurement.

MOUNTING AND MECHANICAL INSTALLATION

For over 40 years, our engineers have been designing encoders that are quick and easy to install. With a variety of mounting options available, your encoder should be a perfect match for your existing equipment. Accessories such as pivoting mounting brackets, measuring wheels, flexible couplings, etc., are available from EPC to ease installation.

The first principle for every encoder installation is "Don't force it!". Striking or using excessive force can either damage your new encoder, or introduce excessive shaft loading, shaft misalignment, or other conditions shortening its expected life. Tighten all couplings and bolts to their recommended torque. Remember, tighter isn't always better!

Shaft Style Encoders



- Gently couple the shaft of the Accu-Coder™ to the driving shaft, using a correctly sized flexible shaft coupling. **Never use a rigid coupling.**
- Verify proper alignment between the Accu-Coder™ shaft and the driving shaft.
- If using pulleys or gears, mount them on the shaft as close as possible to the Accu-Coder™ to reduce bearing load.
- Axial and radial shaft loading should be low as possible. Never exceed printed specifications.
- Use recommended torques to tighten all clamping bolts and couplings.

Hollow Bore Encoders



- Make sure driving shaft is free from burrs and other defects.
- With flex mount flush against surface, tighten clamp or set screws first, then bolt flex mount to surface.
- Check for best possible alignment with hollow shaft and driving shaft to reduce wobble.
- Runout of the driving shaft, or misalignment between the driving shaft and the encoder's hollow bore, decreases the accuracy and bearing life of the encoder and adds vibration to the system. Re-installing the encoder on the driving shaft may improve alignment.

C-Face Style Encoders



- Verify that mounting holes are in exact alignment with holes or studs on the motor frame.
- Tighten all fasteners with equal torque so as not to distort the shape of the ring.

Caution: Avoid damage to your Accu-Coder™. The following actions may cause damage, and void product warranty.

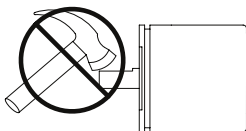

Do not shock or strike.

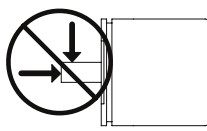

Do not subject shaft to excessive axial or radial shaft stresses.

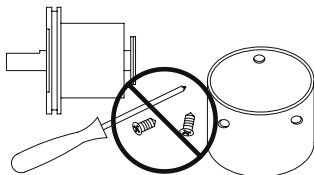

Do not disassemble.

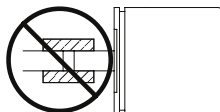

Do not use a rigid coupling.

RECOMMENDED BOLT TORQUES

MODEL	STYLE	DESC./LOCATION	THREAD	TORQUE	HEX KEY
15T/H	All	Set Screws / Shaft	M3	30 to 45 oz-in	1.5 mm
25T/H	Clamp	Clamp Bolt	6-32	10 to 15 lb-in	7/64"
225	All	Set Screws / Shaft	6-32	30 to 40 oz-in	1/16"
260, 960	Clamp	Clamp Bolt	2-56	100 to 120 oz-in	5/64"
702	Flex Hollow	Set Screws / Shaft	6-32	50 to 80 oz-in	1/16"
	Flex Hollow	Clamp Bolt / Shaft	4-40	115 to 160 oz-in	3/32"
755	Flex Hollow	Set Screws / Shaft	6-32	35 to 50 oz-in	1/16"
	Flex Hollow	Set Screws / 0.75" Shaft	4-40	25 to 40 oz-in	0.050"
770	Collet	Cup / Cone Bolts	4-40	120 to 200 oz-in	3/32"
771	1.0" up to 1.375"	Clamp Bolt	8-32	30 to 35 lb-in	9/64"
	>1.375" to 1.875"	Clamp Bolt	6-32	15 to 25 lb-in	7/64"
775	Collet	Cup / Cone Bolts	4-40	120 to 200 oz-in	3/32"
	Clamp	Clamp Bolt	8-32	30 to 35 lb-in	9/64"
776	Clamp	Clamp Bolt	6-32	15 to 25 lb-in	7/64"
770, 775, 776	All	Protective Cover	4-40	70 to 120 oz-in	3/32"
771	All	Protective Cover	3/8"-16	180 to 240 lb-in	5/16"
TR1, TR2	All	Pivot Bolt/Shaft	1/4"-20, M6	40 to 60 lb-in	5/32"
	All	Set Screw/Torque Adj	10-32	15 to 18 lb-in	3/32"
TR1	All	Set Screw/Wheel	4-40	25 to 40 oz-in	0.050"
TR2	All	Set Screw/Pinion	6-32	35 to 50 oz-in	1/16"
	All	Set Screw/Wheel	10-32	35 to 40 lb-in	3/32"
TR3	All	Set Screw/Wheel	10-32	35 to 40 lb-in	3/32"
	All	Spring Pivot Clamp	10-32	30 to 35 lb-in	5/32"

ELECTRICAL CONNECTION

Proper wiring and grounding are essential for the longevity and proper operation of your Accu-Coder™. In addition, electrical noise should be minimized to prevent improper counts and/or damage to the electronic components.

Since an Accu-Coder™ can be used with a wide variety of input devices (PLC's, counters, servo controllers, etc.), from many different manufacturers, it is important to determine proper wiring and connections before installation.

Common Signals

Most Accu-Coder™ encoders have the following electrical connections: Power, Common or Ground, and one or more Output Signals.

Power (Also called supply, power source, encoder power, +V, or +VDC)

- Always use a direct current (DC) voltage.
- Attach power to the positive (+) side of the power source.
- Verify that the Accu-Coder™ is receiving the proper voltage, since most electrical failures are caused by an improper or improperly regulated power source.
- The use of surge protection is highly recommended.

Common (Also called Com, supply common, and ground)

- Attach common to the negative (-) side of the power source.

Output Signals (Always at least one, but may be as many as six)

- The most common are A, B, and Z. Commutation outputs include U, V, and W.
- Encoders with a Line Driver output also have the complement (A and A', B and B', etc.) as separate outputs that are used to provide differential signals for reduced noise and greater drive capability.
- **Never connect the output signals together, or to the power source!**

Connections

- Verify and match up pin numbers, wire colors, or terminal blocks with the input device.
- Be aware that identification terminology may not always be identical.
- Once proper wiring is determined, document it for future reference.

Cable Routing

- Cable length should be minimized by using the shortest route possible.
- All cabling should be installed in dedicated metal conduits, or located at least 12" away from other wiring.
- Route cables away from high current conductors to minimize pulses caused by electrical transients.
- Signal wire continuity should be maintained from the encoder to the controller/counter. Avoid junctions and splices, if possible.

Radiated Electrical Noise

- Noise can be generated by solenoids, relays, motors, starters, and similar devices.
- Using shielded cables will dramatically reduce the effects of noise. Most Accu-Coder™ cables are double shielded (foil and braid) for optimum protection.
- Ensure all equipment is properly grounded. (Motors, drives, shafts, etc.)
- Connect encoder cable shield to ground at controller/counter end, leaving the end near the encoder unconnected. Connecting the shield at both ends can cause ground loops, and improper operation.
- If possible, use *differential line driver* outputs with high quality shielded, twisted pair cable. (Complementary signals greatly reduce common mode noise levels, as well as signal distortion resulting from long cable lengths.)
- EPC's line of Repeaters and Converters may help reduce the effects of electrical noise.

Typical Electrical Hook-Ups

Differential Line Driver

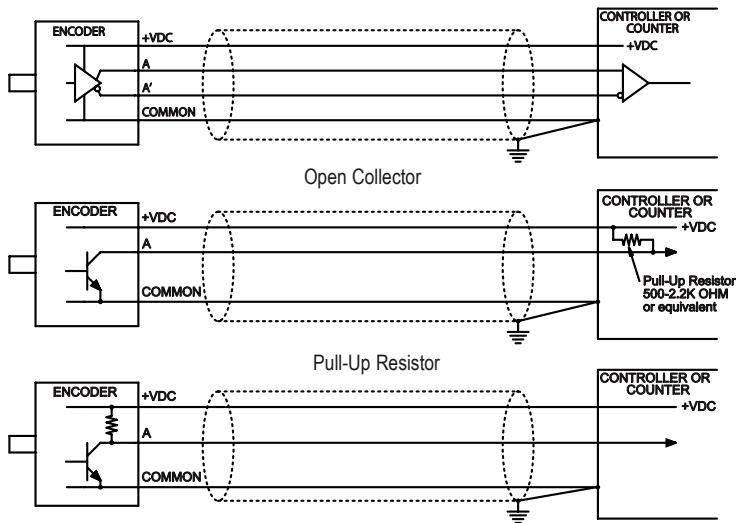

OUTPUT CIRCUIT DIAGRAMS

Open Collector (O, OC, OD)

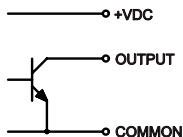

Models 15T/H, 15S, 121, 225, 25T/H, 260, 702, 711, 715-1, 715-2, 716, 725, 755A, 758, 770, 771, 775, 776, 802S, 858S, 925, 958, 960, LCE, TR1, TR2

Pull-Up (S, PU)

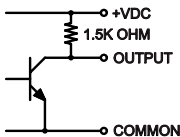

Models 225, 711, 715-1, 715-2, 716, LCE

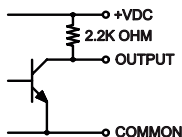

Models 15T/H, 15S, 25T/H, 702, 725, 755A, 758, 770, 771, 775, 776, 802S, 858S, TR1, TR2

Line Driver (HV, H5)

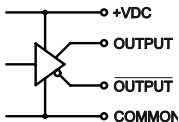

Models 15T/H, 15S, 121, 25T/H, 260, 702, 711, 716, 725, 755A, 758, 770, 771, 775, 776, 802S, 858S, LCE, TR1, TR2

Push-Pull (PP, P5)

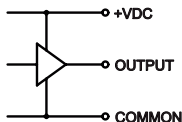

Models 15T/H, 15S, 121, 25T/H, 260, 702, 711, 716, 725, 755A, 758, 770, 771, 775, 776, 802S, 858S, 925, 958, 960, LCE, TR1, TR2

Does your application require signals to be transmitted long distances, or is your signal incompatible with interfacing equipment?

EPC's RXTX Repeater incorporates a Differential Line Receiver on its input, along with a Differential Line Driver at the output. The Line Receiver provides common mode noise rejection, helping to reduce the noise and distortion associated with long cable runs in a plant environment. A Line Driver adds current drive capacity allowing transmission of clean signals over much longer distances. Several RXTX Repeaters can be cascaded, if necessary, for extremely long cable runs. The RXTX Converter is designed to convert differential signals to single ended signals, and vice versa. It can be used to convert to differential signals for long cable runs, or simply to convert to a signal type that is compatible with interfacing equipment.



THE RXTX CONVERTER

INCREMENTAL ENCODER WIRING TABLES

M12 CONNECTORS				
Pin	8 PIN		5 PIN	
	711, 715-1&2, 716, LCE, 15S, 15T/H, 25T/H, 225A/Q, 260, 702, 725, 755A, 758, 770, 771, 775, 776, TR1, TR2, TR3		711, 715-1&2, 716, LCE, 15S, 15T/H, 25T/H, 225A/Q, 260, 702, 725, 755A, 758, 770, 771, 775, 776, TR1, TR2, TR3	
	HV, H5	O, OC, S, PU, PP, P5	O, OC, S, PU, PP, P5	
Func	Func	Func		
1	A	A	+VDC	
2	+VDC	+VDC	B	
3	A'	---	Com	
4	B	B	A	
5	B'	---	Z	
6	Z	Z	---	
7	Com	Com	---	
8	Z'	---	---	

CE Option: Read Technical Bulletin "TB111" at www.encoder.com



D-SUB MINIATURE (9-pin) CONNECTORS				
Pin	702, 725, 775, 776		225A	225Q
	HV, H5	OC, PU, PP, P5	OC, PU	OC, PU
	Func	Func	Func	Func
1	+VDC	+VDC	+VDC	+VDC
2	A	A	A	A
3	A'	---	---	---
4	B	B	---	B
5	B'	---	---	---
6	Z	Z	---	---
7	Z'	---	---	---
8	Case*	Case*	---	---
9	Com	Com	Com	Com

*702, 725 Pin * is Always connected to Case
 *775, 776 Non-CE Option: Pin 8 has No Connection. CE Option: Pin 8 is connected to Case

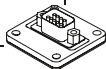

M12 CORDSETS				
Function	CONDUCTORS			
	8	5	4	3
Com	Blue	Blue	Blue	Blue
+VDC	Brown	Brown	Brown	Brown
A	White	Black	Black	Black
A'	Green	---	---	---
B	Yellow	White	White	---
B'	Gray	---	---	---
Z	Pink	Gray	---	---
Z'	Red	---	---	---
Case	Bare*	Bare*	Bare*	Bare*

*Only on specified cordsets. See Technical Bulletin "TB111" at www.encoder.com



MS CONNECTORS						
Pin	10-PIN		7-PIN		6-PIN	
	711, 716, LCE, 25T/H, 702, 725, 758, 770, 771, 775, 776		711, 716, LCE, 25T/H, 702, 725, 758, 770, 771, 775, 776		711, 716, LCE	711, 715-1/2, 716, LCE, 25T/H, 702, 725, 775, 776
	HV, H5	HV, H5	O, OC, S, PU, PP, P5	HV (No Index)	O, OC, S, PU, PP, P5	
Func	Func	Func	Func	Func	Func	
A	A	A	A	Com	Com	
B	B	B	B	+VDC	+VDC	
C	Z	A'	Z	A	Z	
D	+VDC	+VDC	+VDC	A'	A	
E	---	B'	---	B	B	
F	Com	Com	Com	B'	Com	
G	Case*	Case*	Case*	---	---	
H	A'	---	---	---	---	
I	B'	---	---	---	---	
J	Z'	---	---	---	---	

*711, 716, LCE, 25T/H, 702, 725, 758-
 Pin G is Always connected to Case
 *770, 771, 775, 776- Non-CE Option: Pin G has No Connection
 CE Option: Pin G is connected to Case

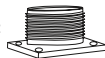

INCREMENTAL ENCODER WIRING TABLES (Continued)

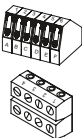

CABLE OPTIONS									
	Func	15T/H, 15S, 121, 25T/H, 260, TR1, TR2		755A	702, 725, 758, 858S, 802S, 770, 771, 775, 776	711, 715-1, 715-2, 716, LCE		225A	225Q
		HV, OC, LO	OC, PP, PU	HV, H5, OC, PU, PP, P5	HV, H5, OC, PU, PP, P5	HV	O, OC, S, PU, PP	OC, PU,	OC, PU,
		Wire Color	Wire Color	Wire Color	Wire Color	Wire Color	Wire Color	Wire Color	Wire Color
	Com	Black	Black	Black	Black	Black	Black	Black	Black
	+VDC	White	White	White	Red	Red	Red	Red	Red
	A	Brown	Brown	Brown	White	White	White	White	White
	A'	Yellow	---	Yellow	Brown	Brown	---	---	---
	B	Red	Red	Red	Blue	Blue	Blue	---	Green
	B'	Green	---	Green	Violet	Violet	---	---	---
	Z	Orange	Orange	Orange	Orange	Orange	Orange	---	---
Z'	Blue	---	Blue	Yellow	Yellow	---	---	---	
U	Violet	Violet	---	---	---	---	---	---	
U'	Gray	---	---	---	---	---	---	---	
V	Pink	Pink	---	---	---	---	---	---	
V'	Tan	---	---	---	---	---	---	---	
W	Red/Grn	Red/Grn	---	---	---	---	---	---	
W'	Red/Yel	---	---	---	---	---	---	---	
Case	---	---	---	Green**	Green**	---	---	---	
Shield	Bare*	Bare*	Bare*	Bare*	Bare*	Bare	Bare	Bare	

*CE Option: Cable shield (bare wire) is connected to internal case
 **Only on Models 702, 725, 758, 802S, 858S
 ***E-Cube Only

TERMINAL BLOCK								
	Pin	770, 771		755A	225A	225Q	711, 715-1, 715-2, 716, LCE	
		HV	OC, PU, PP	HV, H5, OC, PU, PP, P5	OC, PP	OC, PP	HV No Index	O, OC, S, PU, PP, P5
		Func	Func	Func	Func	Func	Func	Func
1	+VDC	+VDC	A	Com	Com	Com	Com	
2	Com	Com	A'	+VDC	+VDC	+VDC	+VDC	
3	A	A	B	A	A	A	Z	
4	A'	---	B'	---	B	A'	A	
5	B	B	Z	---	---	B	B	
6	B'	---	Z'	---	---	B'	Com	
7	Z	Z	Com	---	---	---	---	
8	Z'	---	+VDC	---	---	---	---	
9	Case*	Case*	---	---	---	---	---	

*CE Option Only

MISC OPTIONS

 12-pin  8-pin Molex  10-pin Industrial Clamp	12 Pin (ccw pin layout)		8 PIN MOLEX	10 PIN INDUSTRIAL CLAMP		10 PIN BAYONET	
	758		755A	770, 771		25T/H, 702	
	HV, H5	OC, PU PP, P5	LD. OC, PU, PP	HV	OC, PU, PP	HV, H5, OD, PU, PP, OC, P5	
Pin	Func	Func	Func	Func	Func	Pin	Func
1	B'	---	+VDC	Com	Com	F	Com
2	+VDC Sense	+VDC Sense	Com	B	B	D	+VDC
3	Z	Z	B'	A	A	A	A
4	Z'	---	B	Z	Z	H	A'
5	A	A	Z'	---	---	B	B
6	A'	---	Z	+VDC	+VDC	J	B'
7	---	---	A'	B'	---	C	Z
8	B	B	A	A'	---	K	Z'
9	Case	Case	---	Z'	---	G	Case
10	Com	Com	---	Case*	Case*		
11	Com Sense	Com Sense	---	---	---		
12	+VDC	+VDC	---	---	---		

*CE Option Only

3xx ENCODER CABLE ASSEMBLIES

Function	STANDARD											
	10-PIN MS		7-PIN MS		6-PIN MS		9-PIN D-SUB		12-PIN		10-PIN BAYONET	
	HV	ST	HV	ST	HV	ST	HV	ST	HV	ST	HV	ST
Com	Black	Black	Black	Black	Black	Black	Black	Black	Black	Black	Black	Black
+VDC	Red	Red	Red	Red	Red	Red	Red	Red	Red	Red	Red	Red
A	White	White	White	White	Orange	White	White	White	White	White	White	White
A'	Brown	---	Brown	---	White	---	Brown	---	Brown	---	Brown	---
B	Blue	Blue	Blue	Blue	Green	Green	Blue	Blue	Blue	Blue	Blue	Blue
B'	Violet	---	Violet	---	Blue	---	Violet	---	Violet	---	Violet	---
Z	Orange	Orange	---	Orange	---	Orange	Orange	Orange	Orange	Orange	Orange	Orange
Z'	Yellow	---	---	---	---	---	Yellow	---	Yellow	---	Yellow	---
Case	Green	Green	Green	Green	---	---	---	---	Green	Green	Green	Green
Shield	Bare*	Bare*	Bare*	Bare*	Bare*	Bare*	Bare*	Bare*	Bare*	Bare*	Bare*	Bare*
Com Sense	---	---	---	---	---	---	---	---	Gray	Gray	---	---
+VDC Sense	---	---	---	---	---	---	---	---	Pink	Pink	---	---

*Bare shield wire connected to case only with CE compatible option selected

ABSOLUTE ENCODER WIRING TABLES

Function	19-PIN KPT 02E14-19P	16-PIN	10-PIN* MS	Gland Cable or Mating Conn.	NOTES: * Only available with 8-bit resolution encoders ** Where Fitted *** Direction Control- Standard is CW increasing when viewed from the shaft end. Direction pin is pulled high normally to 5V internally. Direction pin must be pulled low (GND, Common) to reverse count direction. Applied voltage to direction pin should not exceed 5V
	925, 958	925, 958	925	925, 958	
	Pin	Pin	Pin	Wire Color	
S1 MSB	A	3	A	Brown	
S2	B	5	B	White	
S3	C	6	C	Green	
S4	D	7	D	Orange	
S5	E	8	E	Blue	
S6	F	9	F	Violet	
S7	G	10	G	Gray	
S8 LSB 8-bit	H	11	H	Pink	
S9 LSB 9-bit	J	12	---	Red/Green	
S10 LSB 10-bit	K	13	---	Red/Yellow	
S11 LSB 11-bit	L	14	---	Turquoise	
S12 LSB 12-bit	M	15	---	Yellow	
Direction***	R	4	---	Red/Blue	
Case Ground	S	16	---	Drain/Screen	
0V Common	T	1	J	Black	
Special**	U	---	---	White/Red	
+VDC	V	2	I	Red	

Function	Gland Cable	NOTES: * CE Option Only ** Standard is CW increasing count (when viewed from shaft end, and using brown wire for MSB). Red/Blue is pulled up internally to 5 VDC. To reverse count direction, RED/Blue must be pulled low (0 VDC). If 5VDC is applied to Red/Blue, unit remains in standard CW increasing count mode. Count direction can also be reversed by using the Yellow MSB wire instead of the Brown. At no time should voltage applied to Red/Blue exceed 5 VDC.
	960	
	Wire Color	
Common	Black	
+VDC	Red	
S1 cw MSB	Brown	
S1 ccw MSB	Yellow	
S2	White	
S3	Green	
S4	Orange	
S5	Blue	
S6	Violet	
S7	Gray	
S8 LSB 8-bit	Pink	
S9 LSB 9-bit	Red/Green	
S10 LSB 10-bit	Red/Yellow	
S11 LSB 11-bit	Turquoise	
Direction Control**	Red/Blue	
Case Ground*	Shield	

TROUBLESHOOTING

No Output/No Counts

- If there is no mechanical movement, there will be no output. Therefore, verify that the Accu-Coder™ is rotating.
- Check to make sure the proper supply voltage is present. It is best to do this at the Accu-Coder™ end, if possible.
- Verify all wiring between the Accu-coder™, the counter/controller, and the power supply.
- Make sure that the proper signal type (OC, PU, LD, PP) is being used for the application.
- Verify that the counter/controller is properly installed and operational. Consult the appropriate User's Manual if necessary.
- If another Accu-Coder™ is available, try it to determine if the encoder is the problem.

Erratic Output/Missing or Extra Counts

- Electrical: Check for loose wiring connections, ground loops, encoder outputs incompatible with the counter/controller, a noisy power supply, electrical noise, proper termination of shields, or a combination of these problems.
- Mechanical: Check for improper alignment, loose coupling, or, if used, slippage in the measuring belt or wheel.

Counts Indicate Wrong Direction

- Check for reversed wiring of the quadrature signals. Reverse if needed.
- If differential signals are being used, make sure that both sides are properly wired.
- **Note: If an index pulse is being used, reversing the wiring will cause the reference alignment to change.**

Counts In Only One Direction

- Make sure that the counter/controller is capable of, and programmed for, bi-directional counting.
- On quadrature units, both channels (A and B) must be present and operational. Check by using a dual channel oscilloscope.
- Make sure the input selection type programmed into the counter/controller, matches the Accu-Coder™. If there is a mis-match, the system may not work properly.

Index Pulse Not Working

- The index pulse occurs only once per revolution, and can be difficult to check with a volt meter. Check index pulses with an oscilloscope.
- The counter/controller may not be capable of detecting the index pulse at higher RPM's. Slowing down the rotation may allow for detection of the index pulse.
- Verify wiring.

Have You Visited Our Website Lately?

encoder.com

Includes our complete line of products, plus:

- New Products
- Technical Bulletins
- Product-Specific Installation Guides
- Product Specifications
- Product Drawings
- Literature Library
- Direct Replacements
- Accessories
- Videos

Encoder Products Company • P.O. Box 249 • Sagle, ID 83860-0249 • 1-800-366-5412

